



logosol.com



 LOGOSOL



BAND SAWMILLS



CHAIN SAWMILLS



PLANERS



Welcome to a growing family business!

Lift your project with the right equipment!

You can confidently choose Logosol when you are going to work with wood. Every day we talk to customers all over the world who use our machines in their businesses or for building and renovating. After 30 years in the industry, we have both the knowledge and the product range that is required for you to get the maximum benefit from your investment.

The equipment you buy from us today can be supplemented with other machines, and easily be upgraded with new modules and attachments as your business grows. Our products are being used worldwide and they open up new opportunities.



Wood processing is a profitable occupation, whether it is for personal use or for selling. Smelling the scent of wood, working with a log, which then becomes something lasting, this is something I wish many people got the opportunity to experience!

Your equipment is covered by a peace-of-mind guarantee that includes generous warranties and support from skilled technicians. Our main concern is that your machine is safe and works perfectly. Logosol's products have proved to have a very long life. This makes your purchase more economical.

Please visit the Logosol website logosol.com for more information on products, warranties and shipping. We are active on Facebook, Instagram and YouTube. You are very welcome to follow us there!

Bengt-Olov Byström

Bengt-Olov Byström

Bengt-Olov Byström started Logosol in 1989. The company is still owned by the Byström family, with its headquarters in Sweden.



**Largest in the field
of small-scale wood
processing**

**Reliable
deliveries all over
the world**

**Over 30 years
of experience in
the industry**

**Family-owned with
customer-oriented
service**

LOGOSOL

Warranties for a safe buy

2-year warranty

Logosol gives you a 2-year warranty on all machines. Consumable items, such as belts, guide bars and chains, are not covered by the warranty.



2-month money back guarantee

Logosol gives you a two-month money back guarantee on all machines. You can test whether the machine meets your requirements before you make your final decision. If you regret your purchase, you only pay for consumable items and the return shipping.



Support all over the world

We provide service and support on our products. Skilled technicians answer your questions by phone, +46 611 18285, from 8 am to 4 pm all weekdays. You can also get support by email. We are happy to help you!



QR codes

Scan these symbols with the camera of your smart phone to get more information about the products.



This is how you order!

Buying from Logosol is easy. Order from our e-store on www.logosol.com or by phone or email.

Welcome to contact us!

LOGOSOL AB
Fiskaregatan 2
871 33 Härnösand
SWEDEN
Phone: +46 611 182 85 • Email: info@logosol.se
Website: www.logosol.com



SAWMILLS		4
	Chain Sawmills	4
	Chain Sawmills – F2	6
	Chain Sawmills – F2*	8
	Chain Sawmills – Module System	10
	Chain Sawmills – Saw Units	12
	Chain Sawmills – Accessories	14
	Chain Sawmills – Guide Bars and Chains	16
	Chain Sawmills – Sharpening Equipment	17
	Band Sawmills	18
	Band Sawmills – B751	20
	Band Sawmills – B751 PRO	22
	Band Sawmills – B1001	24
	Band Sawmills – Accessories	26
	Band Sawmills – Band Blades	28
	Band Sawmills – Sharpening Equipment	29
	Comparative Table – Chain Sawmills and Band Sawmills	30
	Log Moulding - LM230 and LM410	32
	Wide Slabber – Big Mill	38
	Ultra-Portable Sawmill – Timberjig	42
	Board Edger – C210	46
	Stack Cutter – PK1500	48
	Wood Drying – WDU	50
	Log Handling	52

PLANER/MOULDERS		54
New planer line coming in 2021! Keep updated on our website!		
	Planer/moulders – Cutting tools	56
	Planer/Moulders – Custom-made knives	57
	Planer/Moulders – Moulding knives: filtering on the website	58
	Planer/Moulders – Chip Management	58
	Planer/Moulders – Tormek Knife Grinder	59

INFORMATION FROM LOGOSOL		60
--------------------------	--	----

Follow us on social media.

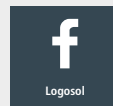

Logosol

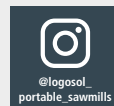

@logosol_portable_sawmills

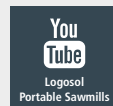

Logosol Portable Sawmills



logosol.com/store/newsletter

Price changes, errors and misprints are reserved.

CHAIN SAWMILLS



F2:

I dream of felling a densely grown spruce and then sawing it into boards!

Hans Goine



Robust and easy to use

The Logosol chain sawmills cut with impressive precision and suits both beginners and experienced sawyers. You get started quickly and get good results immediately. The chain sawmills are easy to use. On the very first day, you can produce a good-sized stack of planks and boards!

30 000 chain sawmills sold in over 100 countries

Over 30 years' experience of small-scale sawing

Both for portable & stationary use



Advantages of our chain sawmills

- ✓ A saw carriage that slides perfectly on the guide rail, and is prepared for bar nose steering, water cooling and vibration-damping feeding crank.
- ✓ Exclusive and durable surface finish. It never rusts and is dirt-repellent. Can stand outdoors all year round.
- ✓ A smart ratchet system with clear scales gives quick and exact height adjustments.
- ✓ The sawmill is built of a smart module system and can be extended and upgraded when required.
- ✓ Strong locking of the guide rail sections facilitates assembly and gives increased stability.
- ✓ Under the guide rail, there is a horizontal, easygrip carrying handle that facilitates lifting the sawmill.
- ✓ Two unique XL log clamps secure the log firmly. They are included as standard.
- ✓ Increased distance between the guide rail and the log enables you to cut knotty and crooked logs without problem.
- ✓ Impressive accuracy. Exact height adjustment gives your timber the right dimensions every time.

From log to boards with the Logosol chain sawmills



The saw unit is easily installed on the carriage, which slides smoothly and accurately on the guide rail.



Clear scales give you the right measurements for each cut. A smart autolocking system allows very quick height adjustments.



The first cut. The log is secured, and the chain cuts easily through the log, giving a fine result.



Pull back the saw unit, raise the log by using the integrated log lifters and cut boards from the log.



A chain sawmill with quality in every detail

The Logosol F2 is a portable sawmill, which easily can cut large logs into sawn timber. In addition, it is so lightweight that you can lift and move it by hand. This sawmill is incredibly easy and fun to use. Even if you have never sawn timber before, you will quickly get started producing planks and boards on day one. You make every cut with impressive precision thanks to the unique, auto-locking log lifters. The Logosol F2 is made of aluminium, a material with amazing properties. You get a maintenance-free sawmill that never rusts, is easy to transport, and can still handle logs that are up to 50 cm in diameter.

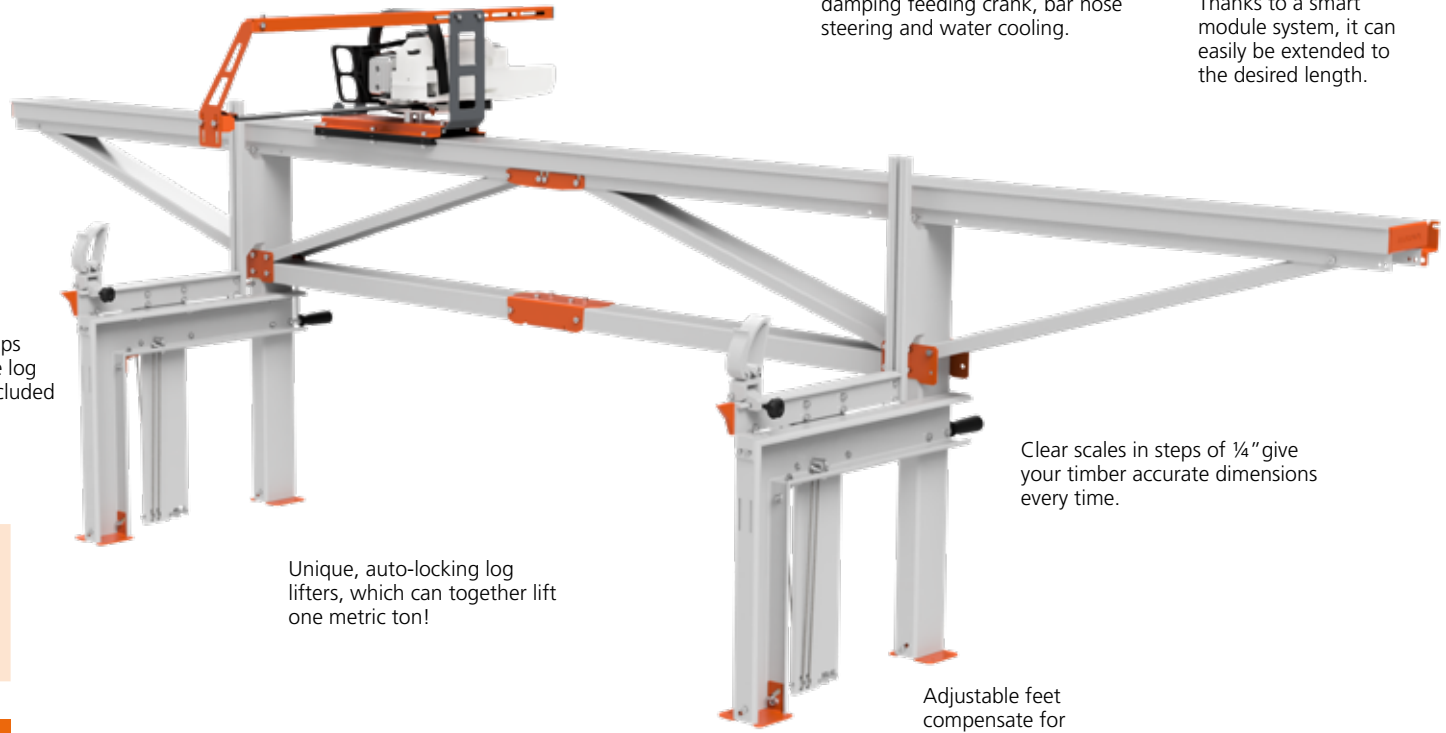

A newly developed saw carriage that slides perfectly, and is easy to lift on and off. Prepared for vibration damping feeding crank, bar nose steering and water cooling.

Thanks to a smart module system, it can easily be extended to the desired length.

Two XL log clamps firmly secure the log into position. Included as standard.

Clear scales in steps of 1/4" give your timber accurate dimensions every time.

Unique, auto-locking log lifters, which can together lift one metric ton!

Adjustable feet compensate for uneven ground.



Included with the F2 chain sawmill

- ✓ 2 XL log clamps
- ✓ Chain saw carriage
- ✓ Unique auto-locking log lifters

Technical data: F2 chain sawmill

Weight: 50 kg
Length: 4, 5 or 6 metres as standard, but it can be extended to the desired length.
Width: 0.7 m
Height: 1.0 m
Log-loading height: 0.6 m
Distance between log lifters: 1 or 2 metres
Log diameter: Up to 50 cm

with the possibility of cutting even larger logs when required.
Log length: 3.7, 4.7 or 5.7 m.
Effective sawing capacity: 3–4 logs per hour.
Accessories: See page 14.
Saw units: Stihl chainsaws MS391/MS661 or Logosol's electric saws and log moulders.



A well-designed sawmill with high quality in every detail. The technology is well tried on earlier generations of this sawmill. Perfect when you want a simple solution without compromising with the result."



Mattias Byström,
Vice President

Tailor your own F2 sawmill

The F2 can be equipped with all our saw units, feed units and log moulders. Contact us, and we will put together a package that suits your needs.

4525-000-2000 F2 chain sawmill, 4 m



A lightweight champion

The F2 is a lightweight sawmill with minimal set-up time. With just a few simple steps, the sawmill is dismantled for transport or storage.

Advantages of the F2 chain sawmill



Easy to transport, store and maintain. Durable, dirt-repellent surface. It never rusts.



Easy to set up. It cuts timber just as well out in the woods as at home in your backyard.



Ideal when you want a simple solution without compromising with the result.

Recommended F2 packages

These are our recommended standard packages. The sawmill can be extended to the desired length. Choose a starter package with guide bar and chain on page 16.

Chainsaw packages

F2, 4 metres, with MS391 chainsaw

Logosol F2 with Stihl MS391, 4 m guide rail, two log lifters, chainsaw carriage. The saw is pushed manually through the log.

4525-555-9391 F2, 4 m, Stihl MS391

F2, 4 metres, with MS661 chainsaw

Logosol F2 with Stihl MS661, 4 m guide rail, two log lifters, chainsaw carriage with basic crank feeding.

4525-555-7661 F2, 4 m, Stihl MS661, basic crank feeding

Electric saw packages

F2, 4 metres, with ES5 electric saw

Logosol F2 with ES5 electric saw (4.6 kW), basic crank feeding, 4 m guide rail, two log lifters.

4525-555-7005 F2, 4 m, ES5 electric saw, basic crank feeding

F2, 4 metres, with ES5 electric saw

Logosol F2 with ES5 electric saw (4.6 kW), manual remote feeding, 4 m guide rail, two log lifters.

4525-555-8005 F2, 4 m, ES5 electric saw, manual remote feeding

F2, 4 metres, with ES8 electric saw

Logosol F2 with ES8 electric saw (8 kW), manual remote feeding, 4 m guide rail, two log lifters.

4525-555-8008 F2, 4 m, ES8 electric saw, manual remote feeding



A plus model for larger logs

Now we can introduce a new, bigger version of the best chain sawmill in the world. The F2+ is an F2 on steroids! This sawmill is sturdier, heavier and meets the demands of customers who want an extra-robust machine for sawing large logs. The log diameter has increased from 50 cm to fully 70 cm. All essential parts of the sawmill are oversized to stand up to the stress of heavy logs, and to create the space needed for bigger logs, the log beds have been reinforced and extended by 20 cm. Even though the F2+ is bigger and a bit heavier than the F2, it has become even easier to handle thanks to a completely new feature that makes it possible to detach the log lifters while keeping the whole guide rail intact and aligned. It has never been easier to store, transport and set up a heavyduty sawmill for oversized logs!



A saw carriage that slides perfectly and is easy to lift on and off. Prepared for vibration-damping feeding crank, bar nose steering and water cooling.

Recommended maximum log diameter has been increased to 70 cm.

A two-part construction for easy handling; the log lifters can be detached from the guide rail.

Stronger log lifters and sturdier beds.

An additional beam stabilizes the frame so that it can carry the weight of large logs.

It stands firmly thanks to the longer distance between the feet.



Included with the F2+ chain sawmill

- ✓ 2 XL log clamps
- ✓ Chain saw carriage
- ✓ Unique auto-locking log lifters

Technical data: F2+ chain sawmill

Weight: 65 kg
Length: 4, 5 or 6 metres as standard, but it can be extended to the desired length.
Width: 0.92 m
Height: 1.0 m
Log-loading height: 0.6 m
Distance between log lifters: 1 or 2 metres
Log diameter: Up to 70 cm with the possibility of cutting

even larger logs when required.
Log length: 3.7, 4.7 or 5.7 m.
Max. log weight in standard design: 1200 kg
Effective sawing capacity: 3–4 logs per hour
Accessories: See page 14.
Saw units: Stihl chainsaws MS661/MS880 or Logosol's electric saws and log moulders.



The detachable guide rail, which can be stored and transported in the same way as a regular ladder, facilitates owning and using the sawmill significantly.”



Mattias Byström,
Vice President

Tailor your own F2+ sawmill

The F2+ can be equipped with all our saw units, feed units and log moulders. Contact us, and we will put together a package that suits your needs.

4530-000-2000 F2+ chain sawmill, 4 m



More space & stronger

We have received feedback from regions where the trees grow larger, as in southern Europe e.g. They have pointed out that the F2 is a bit on the small side for the trees there. By the new design of the F2+ we have met their wish for more space for the log and stronger log lifters.

Tip! In special cases, you can saw logs that have a diameter larger than 70 cm on the F2+. The bar nose steering and the guide bar guard can easily be pushed out if you need to use the whole length of the guide bar.

Recommended F2+ packages

These are our recommended standard packages. The sawmill can be extended to the desired length. Choose a starter package with guide bar and chain on page 16.

Chainsaw packages

F2+, 4 metres, with MS661 chainsaw

Logosol F2+ with Stihl MS661, 4 m guide rail, two log lifters, chainsaw carriage with basic crank feeding.

4530-555-7661 F2+, 4 m, Stihl MS661, basic crank feeding

F2+, 4 metres, with MS661 chainsaw

Logosol F2+ with Stihl MS661, 4 m guide rail, two log lifters, chainsaw carriage with manual remote feeding.

4530-555-8661 F2+, 4 m, Stihl MS661, manual remote feeding

Electric saw packages

F2+, 4 metres, with ES5 electric saw

Logosol F2+ with ES5 electric saw (4.6 kW), basic crank feeding, 4 m guide rail, two log lifters.

4530-555-7005 F2+, 4 m, ES5 electric saw, basic crank feeding

F2+, 4 metres, with ES5 electric saw

Logosol F2+ with ES5 electric saw (4.6 kW), manual remote feeding, 4 m guide rail, two log lifters.

4530-555-8005 F2+, 4 m, ES5 electric saw, manual remote feeding

F2+, 4 metres, with ES8 electric saw

Logosol F2+ with ES8 electric saw (8 kW), manual remote feeding, 4 m guide rail, two log lifters.

4530-555-8008 F2+, 4 m, ES8 electric saw, manual remote feeding

Three advantages of the F2+



The log beds are stronger and longer than before to create the space needed for larger logs.



The log lifters can be detached from the guide rail, which remains intact and aligned.



The log lifters are 50 % stronger than before, to be able to stand up to the increased log weight.



LOGOSOL F2/F2+ module system

Tailored to your needs

Built of a smart module system. Choose between 4, 5 or 6 m sawing length. If you require a longer sawing length, we will fix it!

Not sure which sawmill is right for you?
Look at the comparative table of our chain sawmills and band sawmills on pp.30-31.



4 metres with 2 log lifters

4 m guide rail. Log lengths up to 3.7 metres. Two log lifters.

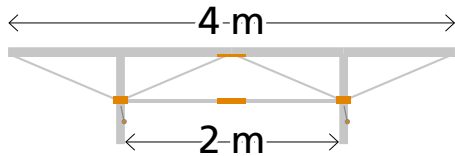

5 metres with 3 log lifters

5 m guide rail. Log lengths up to 4.7 metres. Three log lifters.

Tip! A shorter distance between two of the log lifters enables you to saw short logs that are down to 1 m without reconfiguring the sawmill.

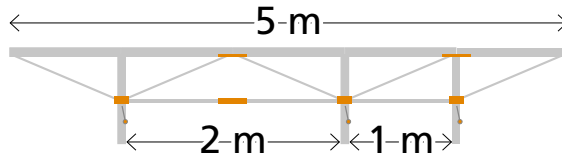

6 metres with 3 log lifters

6 m guide rail. Log lengths up to 5.7 metres. Three log lifters.

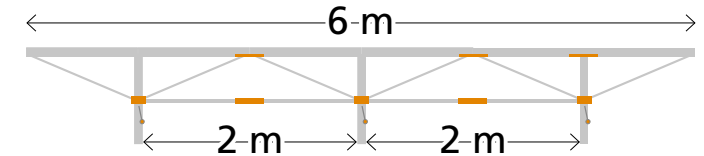

4525-000-2000	Logosol F2, 4 m with 2 log lifters	
4530-000-2000	Logosol F2+, 4 m with 2 log lifters	

4525-000-2005	Logosol F2, 5 m with 3 log lifters	
4530-000-2005	Logosol F2+, 5 m with 3 log lifters	

4525-000-2006	Logosol F2, 6 m with 3 log lifters	
4530-000-2006	Logosol F2+, 6 m with 3 log lifters	



Extend the sawing length when needed

If you need a longer sawmill, we have affordable extensions of the lengths 1 m and 0.5 m. The 1 m extension has to be supplemented with a support leg. The extensions can also be used on older Logosol chain sawmills.



4525-010-2105	Extension 0.5 m	
4525-010-2110	Extension 1.0 m	
6600-000-3005	Support leg for the 1.0 m extension	



With your own sawmill, the only limit is your imagination. If you for instance cut diagonally through the log, you can make material for beautiful signs or chopping boards.

Sawed extra-long beams for a new home



'As a carpenter, I have bought thousands of linear metres of timber at the timber yard. I know how hard it is to find good timber that is suitable. When you cut the timber yourself, you always get the highest quality and the option to cut exactly what you need.'

Björn Christiernsson

Björn Christiernsson needed seven-metre-long beams for the construction of the family's self-designed house, but there was no such thing to buy in the commercial timber yard. Instead he bought an extended chain sawmill from Logosol, and cut the timber to the right length for the project!

"We spent almost two years preparing the site. The trees we felled, I have used when building the house," Björn Christiernsson says.

A total of 150 meters of spruce beams were cut. Today, the visible black-stained wooden structure gives a unique character to the white ceiling, which goes all the way up to the ridge. The maximum clear height is 7 metres.

"This is the most advanced house I've ever built, but it's amazing to be able to get it just the way you want it. When we drew the house plans, we wanted every square meter to have a purpose. Adding a room just because it is 'good to have' often results in a space that will be unused."

CHAIN SAWMILLS saw units

Saw units for the F2 and the F2+

COMPATIBLE WITH F2, F2+ AND OLDER MODELS

Prepared for bar nose steering for the best sawing result



All chainsaws with two guide bar bolts fit on the chainsaw carriage



Saw carriage is included with the F2 and F2+

MS391/MS661 chainsaws

A petrol-driven chainsaw makes you independent of electricity on your working site. Take your chain sawmill out in the woods and cut boards where the trees are. Logosol has carefully selected powerful chainsaws from Stihl, which are perfectly adapted for log sawing.

We recommend the MS391 when you saw a smaller amount of normal-sized logs and occasionally some large-diameter logs. The MS661 is suitable when you saw large amounts of timber and when you saw hardwood or oversized logs.

- ✓ It can handle extreme loads.
- ✓ Always optimum performance and lowest fuel consumption.
- ✓ Easy to start thanks to a decompression valve and ElastoStart.
- ✓ Easy-to-handle and flexible.
- ✓ Sturdy and very low-maintenance.

Technical data: Chainsaw

Recommended guide bar length: 50 or 70 cm. Other lengths are available.

Stihl MS391 chainsaw	Power: 3.3 kW (4.5 hp)	Weight: 6.4 kg
Stihl MS661 chainsaw	Power: 5.3 kW (7.1 hp)	Weight: 7.5 kg

6608-555-0025	Stihl MS391 chainsaw, 3.3 kW (4.5 hp)	
6608-555-0010	Stihl MS661 chainsaw, 5.3 kW (7.1 hp)	

COMPATIBLE WITH F2, F2+ AND OLDER MODELS

Prepared for bar nose steering for the best sawing result



Strong electric motors of 5 or 8 kW

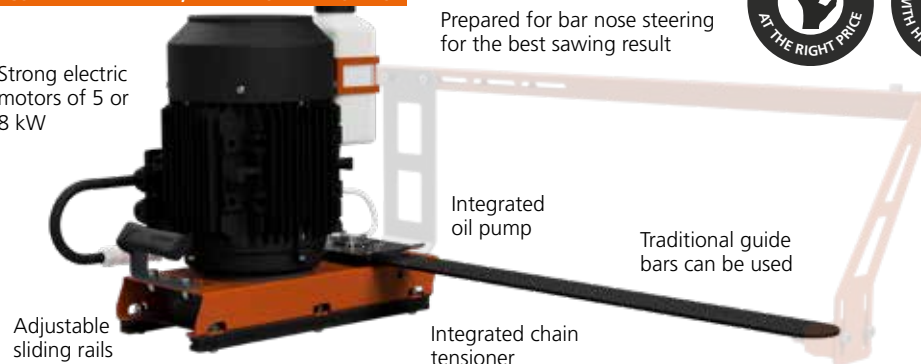

Adjustable sliding rails

Integrated oil pump

Integrated chain tensioner

Traditional guide bars can be used

ES5/ES8 electric saws

Logosol's electric saws offer you a more efficient and quieter sawing. A perfect choice if you have access to electricity at your working site. The electric saws start directly when you press the button and are significantly quieter than a petrol-driven chainsaw. Working with your chain sawmill becomes even more efficient.

We recommend the ES5 when you saw a large amount of normal-sized logs and occasionally some large-diameter logs. The ES8 is suitable when you produce a lot of timber, and when you saw extra hard or oversized timber.

- ✓ Traditional guide bars can be used.
- ✓ Sawdust shield.
- ✓ Integrated chain tensioner.
- ✓ Adjustable sliding rails.
- ✓ Integrated belt tensioner.
- ✓ Low weight.
- ✓ Low noise level.
- ✓ Compatible with all new and older models of Logosol's chain sawmills.

Technical data: Electric saw

Recommended guide bar length: 50 or 70 cm. Other lengths are available.

Included:	Oil pump, chain tensioner, belt tensioner, and more.	
Electrical connection:	3-phase, 400V, 16A maximum power.	
LOGOSOL ES5 electric saw	Power: 4.6 kW (max. 8 kW)	Weight: 35 kg
LOGOSOL ES8 electric saw	Power: 8 kW (max. 16 kW)	Weight: 40 kg

6608-555-xxxx	ES5 electric chainsaw, 4.6 kW (up to 12 hp maximum power)	
6608-555-xxxx	ES8 electric chainsaw, 8 kW (up to 20 hp maximum power)	

Choose a feed unit

COMPATIBLE WITH ELECTRIC SAW AND CHAINSAW

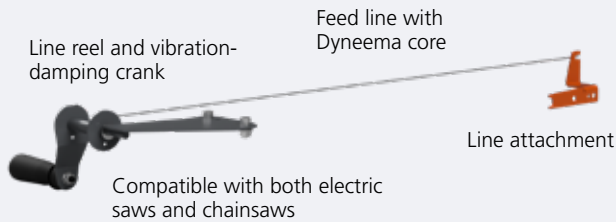

Basic crank feeding

For our saw units you choose between basic crank feeding or manual remote feeding.

With the convenient basic crank feeding, you follow the saw unit along the sawmill. You crank the saw unit smoothly and easily through the log.

The line reel is attached directly to the saw carriage. A line attachment is fitted at the other end of the sawmill. The saw unit is pulled forward with the new and extra strong feed line.

The sturdy crank is vibration-damped and gives a nearly vibration-free grip.

- ✓ Sturdy, vibration-damping feeding crank.
- ✓ Extra strong feeding line with Dyneema core.
- ✓ An affordable option.
- ✓ Compatible with both electric saws and chainsaws.

6600-000-7025	Basic crank feeding for petrol-driven chainsaw
6600-000-7015	Basic crank feeding for electric chainsaw

COMPATIBLE WITH ELECTRIC SAW AND CHAINSAW

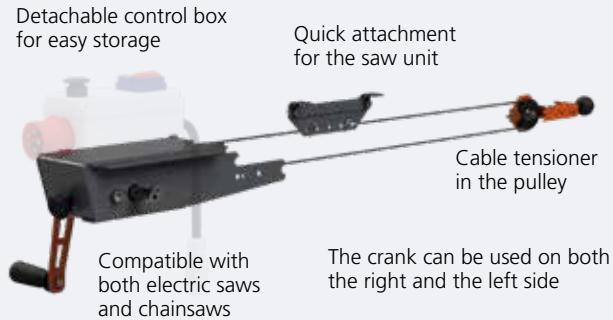

Manual remote feeding

For our saw units you choose between basic crank feeding or manual remote feeding.

With the manual remote feeding, you comfortably control the saw unit from one end of the sawmill. You crank the saw unit forward and back through the log and do not have to stand in the middle of exhaust fumes and sawdust spray. In 2020, there will be an addition that will make it possible to use the remote feeding on chainsaws too.

- ✓ The crank is adjustable to give you a comfortable and ergonomic working position. You can set it to three different height positions and also adjust it for right-hand or left-hand use.
- ✓ Integrated cable tensioner in the pulley.
- ✓ Quick attachment for the saw unit.
- ✓ The control box (for electric saws) can easily be detached for easy storage when the sawmill is not in use.
- ✓ Compatible with both electric saws and chainsaws.

6600-000-7020	Manual remote feeding for petrol-driven chainsaw
6600-000-7010	Manual remote feeding for electric chainsaw

COMPATIBLE WITH ELECTRIC SAW AND CHAINSAW

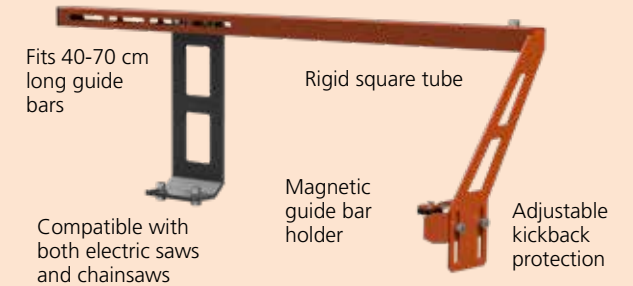

Bar nose steering

You can upgrade your saw unit with the bar-nose steering to get higher precision when making wide cuts.

The tube of the bar-nose steering is adjustable and fits 40-70 cm long guide bars.

The guide bar is held in place by a strong magnetic at the bar nose.

The bar-nose steering makes it easy to adjust the guide bar parallel to the log beds for a perfect sawing result.

- ✓ Adjustable for guide bar lengths between 40 and 70 cm.
- ✓ Magnetic guide bar holder.
- ✓ Adjustable kickback protection.
- ✓ Facilitates alignment with the log beds for perfect sawing results.
- ✓ Compatible with both electric saws and chainsaws.

6600-001-7005	Bar-nose steering for electric & petrol chainsaw
---------------	--

Original accessories – more possibilities for your chain sawmill

More accessories on logosol.com

Increase capacity and facilitate work. With the right accessories you get a sawmill that suits you and your activities! More accessories are available on the website.



FITS F2, F2+ AND OLDER MODELS



XL Log Clamp

It even holds the largest logs in place. Included with the F2 and the F2+. **Recommended!**

4508-001-1027



FITS F2, F2+ AND OLDER MODELS

Gauging Rod

Quick reading of the set sawing height.

4507-001-1300



FITS F2, F2+ AND OLDER MODELS

Chainsaw carriage

Chainsaw carriage with adjustable sliding rails for perfect fit and glide on the guide rail. It also fits older Logosol chain sawmill models.

4525-001-0015



FITS THE CHAINSAW CARRIAGE AND ES5/ES8 ELECETRIC SAWS

Bar nose steering

Upgrade your electric saw or chainsaw with the bar-nose steering to get higher precision when making wide cuts. **Recommended!**

4525-001-0025



FITS ALL MODELS

Smart log table in front of the sawmill!

Log Table

Adjustable width and height. Length 2.4 m, with the possibility of extending it. Of steel.

6101-000-1030



FITS F2, F2+ AND OLDER MODELS

Versatile Log Fence

You quickly get extra support at the right height. Perfect for the longest logs.

4510-720-6104

Find the right spare part

Are you searching for a spare part? Use the feature "Spare part search" in the Logosol e-store and you will easily find the part you need.



Step 1: Select machine

Start by selecting the machine that you want a spare part for. The list of products is continuously updated.

Step 2: Select spare part

Each spare part is shown with a number in a detailed exploded view of the machine. Below the exploded view there is a list, on which each number is shown together with the right product and price.

Step 3: Order your spare part

Call us or buy directly from the e-store. Soon you will have the spare part you need!

CHAIN SAWMILLS accessories



Round Saws

Cut up to 16 sides on the logs. Comes with instructions.



Watch video about round sawing

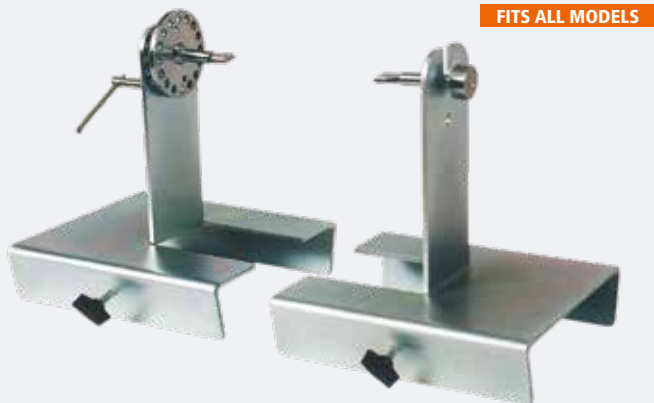

9999-000-1100

Extension packages

The extension packages make it easy for you to extend the sawing length later on.

If you want to extend your old sawmill, it is possible to do so with our extension packages. Please contact us!

Extension package 2 x 0.5 metre

Includes 2 x 0.5 m extensions. Can be combined with the other extension packages.

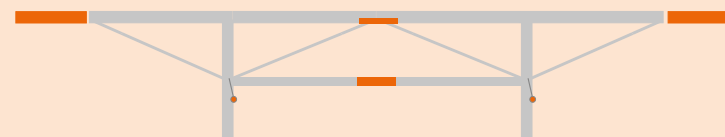

Extension package 1.0 metre with 1 additional log lifter

Includes 1 m extension with 1 additional log lifter. Allows you to saw short logs.

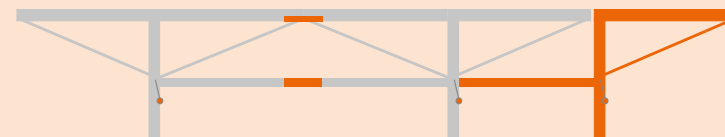

Extension package 2.0 metres with 1 additional log lifter

Includes 2 x 1 m extensions with 1 additional log lifter.

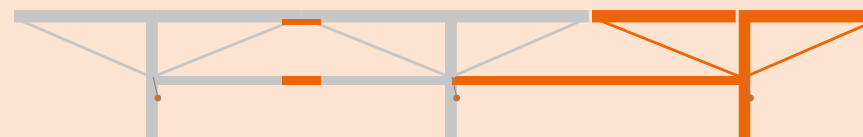

4525-555-0001	Extension package 2 x 0.5 metre, F2	
4525-555-0001	Extension package 2 x 0.5 metre, F2+	
4525-555-0002	Extension package 1.0 metre with 1 additional log lifter, F2	
4530-555-0002	Extension package 1.0 metre with 1 additional log lifter, F2+	
4525-555-0003	Extension package 2.0 metres with 1 additional log lifter, F2	
4530-555-0003	Extension package 2.0 metres with 1 additional log lifter, F2+	

CHAIN SAWMILLS cutting tools

Guide bars and chains for rip sawing

✓ Always quick deliveries! ✓ Hand-picked assortment of high quality! ✓ Easy to order!

GUIDE BARS AND CHAINS

Type: 3/8" 1.3 mm. **Fits:** Stihl MS362, MS391, MS660, MS661 Logosol electric saws ES5 and ES8, and others.

Ref. no.	Brand	Guide bar type	Length	Price	Ripping chain	Price
3003-000-6313	Stihl	Standard	40 cm (16")		3614-000-0060	
3003-000-8613	Stihl	Solid	40 cm (16")		3614-000-0060	
3003-000-8621	Stihl	Solid	50 cm (20")		3614-000-0072	
3010-025-0050	Logosol	Premium	50 cm (20")		3614-000-0072	
3003-000-7831	Stihl	Standard	63 cm (25")		3614-000-0084	
3003-000-5531	Stihl	Solid	63 cm (25")		3614-000-0084	
3010-028-0071	Logosol	Premium	70 cm (28")		3614-000-0092	

Type: 3/8" 1.6 mm. **Fits:** Stihl MS880*.

*All the guide bars and chains require chain sprocket, ref. no. 1124-640-2004

Ref. no.	Brand	Guide bar type	Length	Price	Ripping chain	Price
3002-000-9231	Stihl	Solid	63 cm (25")		3653-000-0088	
3002-000-8041	Stihl	Solid	75 cm (30")		3653-000-0100	
3002-000-8052	Stihl	Solid	90 cm (36")		3653-000-0114	
3002-002-8064	Stihl	Solid	120 cm (47")		3653-000-0152	
3002-001-8076	Stihl	Standard	150 cm (59")		3653-000-0189	

Type: 3/8" 1.3 mm. **Fits:** Logosol electric saws E5 Speed Saw and E8 Speed Saw

Ref. no.	Brand	Guide bar type	Length	Price	Ripping chain	Price
3008-010-1050	Logosol	Ripper (Speed Saw M2)	50 cm (20")		3614-000-0088	
3008-010-1070	Logosol	Ripper (Speed Saw M2)	70 cm (28")		3614-000-0108	
3010-010-3050	Logosol	Premium (Speed Saw M3)	50 cm (20")		3614-000-0084	
3010-010-3070	Logosol	Premium (Speed Saw M3)	70 cm (28")		3614-000-0104	

Type: 3/8" 1.6 mm. **Fits:** Logosol Stack Cutter PK1500

Ref. no.	Brand	Guide bar type	Length	Price	Cross-cut chain	Price
3002-002-8064	Stihl	Standard	120 cm (47")		3673-000-0152	
3002-001-8076	Stihl	Standard	150 cm (59")		3673-000-0189	

CUTTING PACKAGES

Affordable cutting packages for your chainsaw.



10% discount!

Cutting package, Standard

5 chains and 1 Standard guide bar (40 cm).

9999-000-0205



10% discount!

Cutting package, Solid

5 chains and 1 Solid guide bar (50 cm).

9999-000-0210



10% discount!

Cutting package, Premium

5 chains and 1 Premium guide bar (50 cm).

9999-000-0208

CHAIN SPROCKETS

It is important to have a fresh sprocket. Change in time!

Ref. no.	Product	Price
1122-640-2002	Spur sprocket, Stihl MS660/661 3/8"-7 1.6	
1122-640-2006	Spur sprocket Stihl MS660/661 3/8"-7 1,3	
1124-640-2004	Spur sprocket, Stihl MS880 3/8"-7 1.6	
6608-001-0035	Spur sprocket, Speed Saw E5 & E8 (model 1-3)	
0000-642-1223	Rim sprocket, 3/8"-7 MS880, MS661, MS361 1.3/1.6	
0000-642-1240	Rim sprocket, 3/8"-7 MS261	
0000-642-1250	Rim sprocket, 3/8"-8 E4000, E5000, E8000 1.3/1.6	

OUR GUIDE BAR TYPES

Standard

Guide bar made of three metal plates that are welded together. Low weight, but it is a bit more resilient than a solid bar. Good durability.

Solid

A laser-cut, solid, high-quality guide bar. Milled groove for the chain. Stable and wide bar mount and tough hardening. No nose sprocket.

Premium

In cooperation with the best guide bar manufacturer in the world, the Canadian Cannon Bars, Logosol has developed a fantastic, solid guide bar for log sawing. A thinner material in combination with really tough hardening and precise tolerances in the chain groove, give a bar that is ideal for chain sawmills.

Find your cutting tools

When you know exactly what you want, you can use the search feature "Find your cutting tools" in the e-store on logosol.com.

Search tools that simplify!

Step 1: Select the equipment

Guide bars, saw chains, band blades or moulding knives?

Step 2: Select make and size

Select the make or type you want, and the size for your equipment.

Step 3: Order your equipment

Call us or buy directly from the e-store. We guarantee quick deliveries!

CHAIN SAWMILLS sharpening equipment

The easy way to a perfect result

It is easy to keep the cutting tools in good condition. Logosol has the sharpening machines that give you the required sharpness, no matter if you are sawing with a chain or a band blade. Grinding discs are included with all our sharpening machines. Supplement with a diamond grinding disc as well, for an even better result.

AUTOMATIC CHAIN GRINDER

Sharpen chains automatically

An automatic grinder that facilitates your work and ensures a better sawing result. Besides sharpening automatically, it sharpens extremely well and you get the luxury of always having a perfect chain when sawing.

- ✓ It sharpens the chain in 3 minutes!
- ✓ It sharpens both cross-cutting and ripping chains.



Sharpness that gives you a perfect sawn surface.



New lower price!

9999-000-1515	Automatic chain grinder	
9999-000-0505	Grinding disc, stone 150D x 16HD x 4.0T	
9999-000-0508	Diamond grinding disc 145D x 16HD x 3.2T	
9999-000-0506	Grinding disc for depth gauges 150D x 16HD x 6.0T	

MANUAL CHAIN GRINDER

When you have high standards

Sharpen chains for petrol-driven and electric chainsaws. Quick sharpening of all types of chains. Handbook for cutting tools is included!

220V, 180W. 2800 rpm.

Supplement with a diamond grinding disc for an even better result!



9999-000-1565	Manual chain grinder	
9999-000-0509	Diamond grinding disc 145 D x 22 HD x 3.2 T	
9999-001-0100	Depth gauge kit: shaper stone, depth gauge setter and file	

GRINDING DISCS

Diamond grinding discs

Replace the stone disc with a diamond-coated grinding disc. There is a big difference in the sharpening result, no matter if you have a simple chain grinder or a more advanced sharpening machine. Does not require to be rubbed off with a shaper stone, as stone discs do.



9999-000-0508	Diamond grinding disc 145 D x 16 HD x 3.2 T mm	
9999-000-0509	Diamond grinding disc 145 D x 22 HD x 3.2 T	

FILE BY HAND

File the chain in time

The Pferd file holder files both the tooth and the depth gauge at once. Useful when filing chains. A 4.8 mm round file is recommended for 1.3 chains.

9999-000-0450	Bar edge file	
9999-000-0620	Filing vice 39 cm, secures the chain during filing	
9999-000-0410	Pferd file holder 4.8 mm, incl. files	
9999-000-0411	Round file, 4.8 mm	
9999-000-0432	Depth gauge setter	
9999-000-0481	File for depth gauge setter	
9999-000-0513	Shaper stone	
0458-395-1100	Handbook for cutting tools	Free!

WATCH OUR APPRECIATED VIDEO ON CHAIN SHARPENING!



SCAN THE QR CODE TO WATCH VIDEO ON CHAIN SHARPENING!



Get a sharp result with a chain grinder!

'In our new video on chain sharpening, I recommend everyone that owns a sawmill to sharpen their chains with a good chain grinder.

/ Bengt-Olov Byström

BAND SAWMILLS 1



A band sawmill for highest capacity

When you require high capacity and professional performance. Our sturdy band sawmills have impressive precision. Well thought-out functions give a stable structure that allows a smooth operation when producing your own timber.

**Made in Sweden
by Logosol**

Professional performance and high capacity

Quiet and vibration-free sawing



Logosol's band sawmills are easy to use. You work quickly and comfortably and get a perfect sawing result. The log clamps, with sturdy handles and a robust design, secure the log with great force without damaging the timber. They work just as well when you make the first cuts as when you cut the last thin board.

B751:
I appreciate the care taken in the details of the band sawmill.

Mikael Karlsson



From log to valuable boards with band sawmills – simple and exact setting of depth of cut



The exact setting of the saw cut is an appreciated legacy from our chain sawmills. Our customers will recognize this in the solution with an adjustment crank that has fixed steps. One rotation of the crank always equals 1 inch. One step compensates for the kerf. This system is standard on both the B751, the B751 PRO and the B1001.

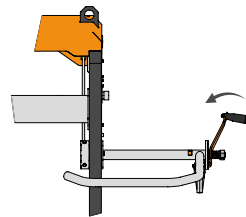

1. Press the crank inwards to release the locking mechanism.

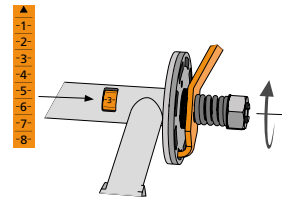

2. Turn the crank one full revolution to set the cut for a 1" board.

360° = 1"

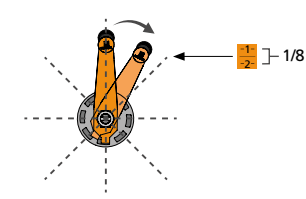

3. Turn the crank one step to compensate for the kerf.

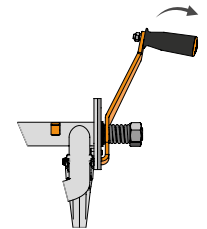

4. Release the crank to lock it in position.

LOGOSOL B751 band sawmill

A band sawmill that thinks forward

The Logosol B751 is manufactured in Sweden by Logosol. In its basic configuration it can saw 4.8-metre-long logs. It can handle large diameter logs, up to 75 cm in diameter. Logosol's in-house developed band sawmill is robust and has several well thought-out features that facilitate work. With exact steps for depth of cut, you cut your timber to the right dimensions, every time. A stable and functional band sawmill that cuts best in its class!

The best system for manual sawhead setting on the market.

Large band wheels with a diameter of 50 cm.

Robust blade guides that you usually only find on considerably bigger and more expensive sawmills.

Design-protected band wheels with fan blades, which cool the blade and blow out the sawdust from the sawhead.

You can cut logs that are up to 75 cm in diameter.

Easy-to-assemble rail frame, and almost fully preassembled sawhead.

Sturdy levelling feet for uneven ground.

4.8-metre sawing length. The sawmill is easy to extend with 1.14 m sections.

See all band sawmill accessories on pp.26-27!

A band sawmill made in Sweden!

- ✓ Robust and well thought-out. A stable design that gives you an amazing sawing result.
- ✓ Quick and accurate setting of depth of cut. The sawhead is adjusted in fixed steps.
- ✓ Strong rails that can stand up to really large logs. Easy to assemble.
- ✓ Log supports with three fixed height positions.
- ✓ The sawmill has several patented solutions and design-protected details.



Logosol's Swedishmade band sawmill has its focus on user-friendliness.

The design is robust and has many spoton technical solutions that you will appreciate when you are sawing. We have been manufacturing sawmills for 30 years and have learnt what works."

Malte Frisk, CEO



Technical data: B751 band sawmill

Capacity

Max. log diameter: 751 mm

Max. cant width: 600 mm

Effective sawing length (standard): 4800 mm

Max. board thickness: 220 mm (8 3/4 inches)

Min. thickness of last board: 25 mm (1 inch)

Band wheels

Band wheel diameter: 500 mm

Maintenance-free wheel bearings. Integrated fan for cooling and effective cleaning of the cover.

Band blades

Blade length: 3843 mm

Blade width: 30-41 mm

Blade speed: 30 m/s

Motor options

Petrol engine: 13 hp or 18 hp. The petrol-driven model has a first-class centrifugal clutch that facilitates the engine

thrust while sawing.

Electric motor: Highly efficient, 4.6 or 8 kW. With the 8 kW motor, the B751 can compete with significantly larger and more expensive band sawmill!

Machine dimensions

Length: 5800 mm
Width: 1967 mm
Height: 1900 mm
Weight: 423 kg

Included with the B751

- ✓ Band blade
- ✓ Levelling feet
- ✓ Adjustable blade guide
- ✓ 1 Log clamp
- ✓ Water cooling
- ✓ 2 log supports

8200-000-0010	B751 with petrol engine 13 hp	
8200-000-0035	B751 with petrol engine 18 hp	
8200-000-0025	B751 with electric motor 4.6 kW	
8200-000-0030	B751 with electric motor 8 kW	
8200-555-0000	Accessory package for the B751: 1 extra log clamp, 1 pair of long log supports and manual toe board	



We have taken note of the best functions of well- tried band sawmill models and added our own experience of log sawing.

Not sure which sawmill is right for you? Look at the comparative tables of our chain sawmills and band sawmills on pp.30-31

Well thought-out in every detail



A unique Last-Cut indicator on the height adjustment scale shows the position of the last cut, and works as a reference for the next. This increases the production.



The band wheels have fan blades, which both blow out the sawdust and keep it clean and tidy inside the sawhead.



Newly developed and patented log holder secures the log with great force. Can be used with one hand.



The best log moulder on the market

Both the B751/B751 PRO Both the B751 and the B1001 are prepared for the log moulder. There are extra attachment points for the log supports that enable you to turn the log easily so you can mill it on the top and the bottom side. No resetting is needed for producing timber that is up to 8 inches, since all moulding knives can be fitted at the same time in the 400 mm wide cutter head. This is a patented solution that facilitates the work by always producing milled grooves that are aligned with the log sides, even if the width along the log differs. The stable design of the log moulder gives a very smooth machined surface. The cutter head is laterally adjustable, making it possible to mill wider than 400 mm if you run it twice over the log. The smallest model, for the B751, can plane and straighten beams that are up to 600x600 mm.

Read more about the LM410 on p.35



Patented log handling. One log clamp and two log supports are included. They secure the log with great force without damaging the timber. They work just as well when you take the first cuts as when you cut the last thin board.

LOGOSOL B751 PRO band sawmill

Extremely sturdy band sawmill with lots of accessories

The extremely stable rail frame and the wheel bogie of the sawhead that were launched together with our large band sawmill B1001, are now also standard on our new band sawmill model B751 Pro. This means that many of the accessories that earlier only could be used on the B1001, now are compatible with the B751 Pro. Among the accessories, there are a trailer kit, a log handling system and a log moulder. The B751 Pro can also be equipped with Logosol's advanced, digital sawmill control system, Smart Set.

The best system for manual sawhead setting on the market.

Prepared for installation of trailer kit and the Smart Set system.

Stable and exact blade guiding that you usually only find on considerably bigger and more expensive sawmills. With ball bearings and without any play.

Partly preassembled sawhead and easy-to-assemble rail frame.

Strong motor options. Petrol engine of 23 hp or electric motor of 12 kW.

Design-protected band wheels with fan blades, which cool the blade and blow out the sawdust from the sawhead.

Sturdy, pivotable levelling feet for uneven ground are included.

Strong rail frame that stays perfectly straight even under the load of the largest logs.

B751 PRO – with every opportunity to upgrade afterwards

- ✓ All accessories for the B1001 are compatible with the B751 Pro, e.g. Trailer Kit and Smart Set.
- ✓ Strong rail frame of torsionally rigid steel tubes.
- ✓ In its standard configuration, it can handle really large logs, almost 5 metres long. Easy to extend.
- ✓ Extremely stable band sawmill that is easy and comfortable to use.
- ✓ Quick and exact setting of the saw cut, the sawhead is adjusted in fixed steps.
- ✓ A Last-Cut Indicator shows the position of your last cut and works as a reference for the next.
- ✓ The band wheels with integrated cooling fans blow out the sawdust far away from the sawmill.
- ✓ In addition to the effective, integrated cooling fans that cool the blade, there is also a water cooling that can be used if needed.

4.8-metre sawing length. If you are going to cut longer logs, you can extend the sawmill to any length.

See all band sawmill accessories on pp.26-27!



Technical data: B751 PRO band sawmill

Capacity

Max. log diameter: 751 mm

Max. cant width: 600 mm

Effective sawing length (standard): 4800 mm

Max. board thickness: 220 mm (8 3/4 inches)

Min. thickness of last board: 25 mm (1 inch)

Band wheels

Band wheel diameter: 500 mm.

Maintenancefree wheel bearings. Integrated fan for cooling and effective cleaning of the cover.

Band blades

Blade length: 3843 mm

Blade width: 33 or 34 mm

Blade speed: 30 m/s

Motor options

Petrol engine: 18 hp with electric start. The petrol-driven model has a first-class centrifugal clutch that facilitates

the engine thrust while sawing.

Electric motor: Highly efficient motor of 8 kW. With that power the B751 Pro can compete with significantly larger and more expensive band sawmill!

Machine dimensions

Length: 5839 mm

Width: 1967 mm

Height: 1920 mm

Weight: 464 kg

Included with the B751 PRO

- ✓ Band blade
- ✓ Levelling feet
- ✓ Adjustable blade guide
- ✓ Water cooling
- ✓ 2 log clamps
- ✓ 2 short log supports
- ✓ 2 long log supports

8200-000-0031	B751 PRO with 8 kW electric motor	
8200-000-0046	B751 PRO with 18 hp petrol engine and electric start	
8400-777-0000	Accessory package for B751 PRO: hydraulic toe board and protective cover	



Now, with the same possibilities as our largest band sawmill B1001, but at a lower price.

News for the B751 PRO:

- ✓ Log loader/log turner
 - ✓ Loading ramps
 - ✓ XL Log handling
 - ✓ XL Support legs
- Read more on page 27.

Strong and torsionally rigid log bed

In its standard configuration, the Logosol B751 Pro can cut really large logs, nearly 5 metres long and fully 75 cm in diameter. If you are going to cut longer logs, the sawmill can be extended to any length. The sturdy rail frame of torsionally rigid steel tubes is generously strengthened and adapted for sawing directly on the ground or on a trailer. The tube construction of the rail optimizes the torsional rigidity. This gives a lightweight and strong design that stays perfectly straight even under the load of the largest logs.



Two selected motor options with power

For the B751 Pro we recommend a little stronger motor options, either our 18 hp petrol option or our fully 8 kW electric option. The electric motors are highly efficient and give close to double the rated power during operation. In horsepower, that means about 20 hp. With the 8 kW electric motor, the B751 Pro can compete with considerably larger and more expensive band sawmills.



This will be our most popular band sawmill. The perfect combination of price and awesome performance.”

Malte Frisk, CEO



LOGOSOL B1001 band sawmill

See all band sawmill accessories on pp.26-27!

Next-generation band sawmill – loaded with power and capacity

The B1001 is the largest of Logosol's band sawmills. The model is Swedish-made and offers a revolutionary design. Logs up to 1001 mm in diameter can be sawn on this sawmill. With the unique height adjustment of the sawhead, you easily produce boards of the dimensions you desire, just as accurately every time. The Logosol B1001 is an extremely stable band sawmill that gives you amazing capacity. The sturdy rail frame is designed such that it by a wide margin can stand up to the weight of the large logs this sawmill can cut.

The best system for manual sawhead setting on the market.

Prepared for installation of trailer kit and the Smart Set system.



Partly preassembled sawhead and easy-to-assemble rail frame.

Strong motor options. Petrol engine of 23 hp or electric motor of 12 kW.

Design-protected band wheels with fan blades, which cool the blade and blow out the sawdust from the sawhead.

Strong rail frame that stays perfectly straight even under the load of the largest logs.



Stable and exact blade guiding that you usually only find on considerably bigger and more expensive sawmills. With ball bearings and without any play.

B1001 – the largest Logosol band sawmill

- ✓ Robust and well thought-out. A stable design that gives you an amazing sawing result.
- ✓ A Last-Cut indicator on the height adjustment scale shows the position of the last cut, and works as a reference for the next.
- ✓ Two log clamps secure the log with great force without damaging the wood. They are patent-pending and have sturdy handles and a robust design. They work just as well when you take the first cut as when you cut the last, thin board.
- ✓ Developed from the ground up, where integrated functions give a clean design and easy use.
- ✓ The patent-pending, light-metal band wheels are combined fan blades that cool the band blade and work as air brakes. In addition, they keep it clean and tidy both at the worksite and inside the sawhead – a great advantage when changing blades or when other maintenance services are made.
- ✓ The sawmill has several patented solutions and design-protected details.
- ✓ More smart accessories are being developed.

4.8-metre sawing length. If you are going to cut longer logs, you can extend the sawmill to any length.

Sturdy, pivotable levelling feet for uneven ground are included.

Technical data: B1001 band sawmill

Capacity

Max. log diameter: 1001 mm

Max. cant width: 850 mm

Effective sawing length (standard): 4850 mm

Max. board thickness: 220 mm (8 3/4 inches)

Min. thickness of last board: 25 mm (1 inch)

Band wheels

Band wheel diameter: 500 mm. Maintenance-free wheel bearings. Integrated fan for cooling and effective cleaning of the cover.

Band blades

Blade length: 4310 mm

Blade width: 30-41 mm

Blade speed: 30 m/s

Motor options

Petrol engine: 23 hp.

The petrol-driven model has a first-class centrifugal clutch that facilitates the engine thrust while sawing. **Electric motor:** Highly efficient motor of fully 12 kW with automatic Y/D starter.

Machine dimensions

Length: 5860 mm

Width: 2338 mm

Height: 2300 mm

Weight: 630 kg

Included with the B1001

- ✓ Band blade
- ✓ Levelling feet
- ✓ Adjustable blade guide
- ✓ Water cooling
- ✓ 2 log clamps
- ✓ 2 short log supports
- ✓ 2 long log supports

8300-000-0010	B1001 with petrol engine 23 hp B&S	
8300-000-0030	B1001 with electric motor 12 kW 400 V	
8310-001-0030	Hydraulic toe board	



The B1001 equipped with the trailer kit gives you a mobile sawmill for oversized logs. Having the sawmill on wheels facilitates setting up and storing the machine. The log table should be approx. 60 cm in height to enable log loading on a level with the sawmill. Loading and log handling devices are also available as accessories.



Easy assembly – you get started quickly with the sawing!

From the operator's perspective

When designing our band sawmills, we have had the operator's perspective in focus and ensured a sawmill that is easy to assemble, with a partly preassembled sawhead and a simple rail frame assembly. The water cooling is easy to adjust and the plastic protective covers, with internal blade guards of metal, are lightweight.



Strong and generous rail frame

In its standard configuration, the B1001 can cut really large logs, up to 4.8-metre-long and 100 cm in diameter. If you are going to cut longer logs, the sawmill can be extended to any length. The sturdy rail frame is generously strengthened and especially adapted for sawing directly on the ground or on a trailer. A tube construction optimizes the torsional rigidity. This gives a lightweight and strong rail frame that stays perfectly straight even under the load of the largest logs.

Powerful motors give high capacity Prepared for automated log handling

There is a petrol engine option of 23 hp, and an electric motor option of 12 kW. The petrol-driven option is a pro engine from Briggs & Stratton. The electric motor is highly efficient and gives close to double the rated power during operation, if needed.



Smart Set has a software that helps you saw accurately and efficiently. Soon, you will also be able to equip your sawmill with a strong system of hydraulic tools for handling heavy logs.



More on SMART SET on p.26!

Smart Set – control your sawmill digitally

Automatic feed and digital and motorized adjustment of each saw cut. With smart software and a lot of presets, you work quickly, easily and efficiently when you are sawing. The Smart Set digital sawmill control system has been developed with the operator in focus. In many industrial applications, old hydraulic machinery is replaced with computer-controlled electric machines and robots to obtain the precision and control required to be competitive today. We think this is the future in our industry as well, with software and electric motors running all essential functions of the sawmill. After several years of development work, we are very happy to apply this software to our band sawmills. Cutting perfect boards with high efficiency has never been easier and more fun. Compatible with B751 PRO and B1001.



Are you searching for a spare part? use the feature “Spare part search” in Logosol’s e-store and you will easily find the part you need. Read more on p.14.



Trailer kit with support legs

Make your sawmill mobile. Compatible with B1001 and B751 Pro.

- ✓ Smart two-position drawbar. The drawbar is pulled out when transporting, and pushed back after set-up. This means that you can move freely around the sawmill without tripping over the trailer coupler.
- ✓ The rail frame is self-supporting.
- ✓ Quick-release attachments for the fenders.
- ✓ Attachment for securing the sawhead and saw carriage for transport.



8260-000-0020	Smart Set, for B751 PRO with petrol engine	
8250-000-0020	Smart Set for B1001 with petrol engine	

8410-001-0035	B751 PRO	
8310-001-0035	B1001	

BAND SAWMILLS accessories

See all band blades for the B751, B751 PRO and B1001 on page 28!



Log handling package – manual log handling for large logs

Save time and effort with smart tools! A complete package for log handling. Includes log loader/turner, 2 loading ramps, 2 XL log holders, conversion kit for anti-tip plates, and 3 XL support legs.

8200-555-0015	B751 PRO	
8300-555-0015	B1001	

Log loader/turner

A smart crane with winch that allows you to easily load and rotate large logs on the sawmill. It can easily be folded away during sawing. Requires conversion kit for the anti-tip plates.



8210-001-0090	B751 PRO	
8310-001-0070	B1001	

Loading ramps

Loading ramps with non-slipping devices make loading logs easier than ever.



8310-001-0090	2 st	
---------------	------	--

XL Support legs

Stable support legs for permanent installation of the sawmill. Should be used together with the log handling package if a trailer kit is not used. Requires conversion kit for the anti-tip plates.



8210-001-0080	B751 PRO, 3 pcs	
8310-001-0060	B1001, 3 pcs	

XL Log holders

Extra strong log clamps and log supports, which even hold the largest logs in place. Trailerkit or XL support legs are recommended.



8210-001-0100	B751 PRO, 2 pcs	
8310-001-0080	B1001, 2 pcs	

Conversion kits for anti-tip plates

For the log loader/turner and the XL support legs.

8310-001-0110		
---------------	--	--



Extra log clamp package

Strong log clamp that holds the log in a firm grip. Includes log clamp attachment and log clamp.

8210-555-0010	B751/B751 PRO	
8210-555-0005	B1001	
8210-001-0020	Only the log clamp	



Hydraulic toe board

Manual hydraulic toe board for quick adjustment of the top end of the log.

8210-001-0070	B751/B751 PRO	
8310-001-0030	B1001	



Manual toe board

For quick and easy adjustment of the top end of the log. For logs that are under 50 cm in diameter. Integrated cant hook. For the B751 and B751 PRO.

8210-001-0010	B751/B751 PRO	
---------------	---------------	--



Protective cover

Neat and practical protective cover in sturdy PVC for your sawmill. For the B751, B751 PRO and B1001.

9031-011-0004	Cover for B751/B751 PRO	
9031-011-0005	Cover for B1001	

Extra pair of log supports

Short and long log supports. For the B751, B751 PRO and B1001. 1 pair.



8210-001-0030	Short log supports, 1 pair	
8210-001-0015	Long log supports, 1 pair	



Extensions

Saw rail extension. Extend your sawmill and cut longer logs.

8210-001-0005	B751, 1140 mm	
8210-001-0060	B751 PRO, 1156 mm	
8310-001-0005	B1001, 1156 mm	

BAND SAWMILLS cutting tools

We have pro blades for your band sawmill

Mount pro blades in your band sawmill and notice the difference! No matter what model you have, you will find the right band blades at Logosol. In most cases we have the band blades in stock so you can have a quick delivery. We also give you quick deliveries of other lengths than standard. With two suppliers of band blades, we offer you a complete range. Choose between Standard, HSS or Premium (carbide). The latter is a firstclass blade for log sawing, which stays sharp significantly longer due to cutting teeth of cemented carbide.

STANDARD

When using a standard blade, change or re-sharpen the blade every other operating hour to get the best sawing result. Easy to sharpen.



STANDARD Band blades			
Ref. no.	Sawmill model	Dimensions	Price/5
9007-033-3843	B751/B751 PRO	3843x33x1.1 mm	
9007-033-4310	B1001	4310x33x1.1 mm	
9000-032-2760	BS350	2760x33x1.1 mm	
9007-033-3570	Lennartsfors	3570x33x1.1 mm	
9007-033-3660	LM40/ML26/LM29/MN26	3660x33x1.1 mm	
9007-033-4000	LT10/LT15/LT20/LT40	4000x33x1.1 mm	
9007-033-4246	LM Pro/HD36	4246x33x1.1 mm	

Quick deliveries!
We have many blades in stock to ensure quick deliveries!



Blade tension gauge

Quick and exact measurement of the blade tension.

8030-001-0059

They fit most models – order pro blades!

- ✓ Specially designed teeth.
- ✓ Strong and flexible steel quality.
- ✓ Suitable for high-production sawing.
- ✓ Sold in packs of 5. (Premium is sold in 1-packs)
- ✓ Made in Sweden.

HSS

The HSS blade is of high quality and stays sharp for about 3 operating hours. Easy to sharpen.



HSS Band blades			
Ref. no.	Sawmill model	Dimensions	Price/5
9007-034-3843	B751/B751 PRO	3843x34x1.1 mm	
9007-034-4310	B1001	4310x34x1.1 mm	
9003-034-2760	BS350	2760x34x1.1 mm	
9007-034-3570	Lennartsfors	3570x34x1.1 mm	
9007-034-3660	LM40/ML26/LM29/MN26	3660x34x1.1 mm	
9007-034-4000	LT10/LT15/LT20/LT40	4000x34x1.1 mm	
9007-034-4246	LM Pro/HD36	4246x34x1.1 mm	

Find your cutting tools

When you know exactly what you want, you can use the search feature "Find your cutting tools" in the e-store on logosol.com.

Step 1: Select the equipment

Guide bars, saw chains, band blades or moulding knives?

Step 2: Select make and size

Select the make, type, and size you want for your equipment.

Step 3: Order your equipment

Call us or buy directly from the e-store. We guarantee quick deliveries!

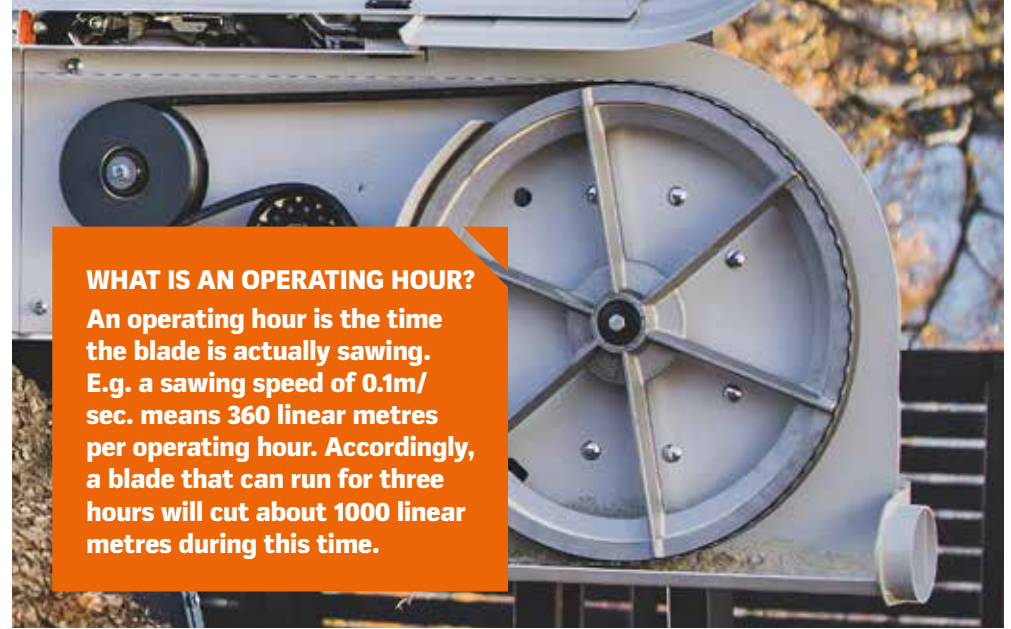

WHAT IS AN OPERATING HOUR?

An operating hour is the time the blade is actually sawing. E.g. a sawing speed of 0.1m/sec. means 360 linear metres per operating hour. Accordingly, a blade that can run for three hours will cut about 1000 linear metres during this time.

PREMIUM (CARBIDE)

This blade stays sharp for a very long time. This blade works best together with stronger sawmill motors. Brazed carbide teeth and a variable pitch give an amazing sawn surface. We have experienced up to 20 operating hours with this blade. It saves a lot of time. **The Premium blades are sold separately!**



PREMIUM Band blades			
Ref. no.	Sawmill model	Dimensions	Price/1
9004-134-3843	B751/B751 PRO	3843x34x1.1 mm	
9004-134-4310	B1001	4310x34x1.1 mm	
9004-134-3660	LM40/ML26/LM29/MN26	3660x34x1.1 mm	
9004-134-4000	LT10/LT15/LT20/LT40	4000x34x1.1 mm	
9004-134-4246	LM Pro/HD36	4246x34x1.1 mm	



Search tools that simplify!

BAND SAWMILLS sharpening equipment

The blades become as good as new!

The **Logosol Grindlux** sharpens your band blades fully automatically. A feeder arm feeds the blade forward and a clamp, which is fitted to the blade, turns the machine off when it has sharpened the whole way round. Tooth rake angle, gullet depth and take-off are adjustable.



Razor-sharp
sawblades are
crucial for a perfect
sawing result!



9999-000-1505 | Logosol Grindlux



Tip! How to keep the sharpness

- ✓ Let the teeth guard stay on until the blade is installed on the sawmill. The toothed side of the blade must never come into contact with the ground or other hard materials.
- ✓ Cool with water while sawing.
- ✓ Adapt the feed pressure to ensure that the blade never touches the rear flange of the blade guide roller.
- ✓ Loosen the blade tension when you are not using the sawmill or when you take a break longer than one hour.
- ✓ Lubricate the blades with universal oil, 9999-000-5105, when they are not being used, see page 28.



Handbook for free!

This booklet is packed with useful tips that improve your sawing result. *The Handbook for Your Guide Bar & Chain* is available for free download on the Logosol website.



Download it today on www.logosol.com



SAWMILLS model comparison

Are you dreaming of sawing high-quality timber of all possible dimensions? No matter if you are sawing with a chain or a band blade you can always choose Logosol, the complete supplier of sawmills and machines for profitable wood processing. In our range of products you find everything from simpler chain sawmills to high-efficiency band sawmills.

Watch us cut timber live online!

Now you can take part in our product demos digitally. Take the opportunity to ask questions about our sawmills to our knowledgeable sales team directly in the chat and get user tips and advice. Watch us livestreaming on our channels on Youtube and Facebook!



You find us at [Logosol Portable Sawmills](#) on YouTube and Facebook.

You can always watch the livestream afterwards, if you don't have the opportunity to watch live.



CHAIN SAWMILLS

The Logosol line of chain sawmills consists of the most sold chain sawmills in the world, and we have happy customers all over the world. These sawmills have the same basic design and can handle really heavy logs.



F2 Chain Sawmill



F2+ Chain Sawmill

Weight	4 m: 50 kg, 5 m: 62.5 kg, 6 m: 75 kg	4 m: 65 kg, 5 m: 77.5 kg, 6 m: 90 kg
Length	4, 5 or 6 m	4, 5 or 6 m
Width	0.7 m	0.92 m
Effective sawing length	3.7 m	3.7 m
Extensions	Sections of 1 m, or 0.5 m on each end	Sections of 1 m, or 0.5 m on each end
Log diameter	Up to 50 cm	Up to 70 cm
Distance between log lifters	1 or 2 m	1 or 2 m
Detachable guide rail	No	Yes
Reinforcement beam	No	Yes
Assembly	Easy to dismantle for transport or storage.	Easy to dismantle for transport or storage. The guide rail can be detached and transported while retaining its adjustments.
Motor options	Chainsaw (MS391 and MS661), electric saw (ES5 and ES8), log moulder (LM230)	Chainsaw (MS661 and MS880), electric saw (ES5 and ES8), log moulder (LM230)
Included	2 XL log clamps, saw carriage, auto-locking system	2 XL log clamps, saw carriage, auto-locking system
Accessories	Extensions, feed units, feed crank, bar nose steering and more.	Extensions, feed units, feed crank, bar nose steering and more.

Advantages of the Logosol chain sawmills

- ✓ Easy to set up. It cuts timber just as well out in the woods as at home in your backyard.
- ✓ Impressive accuracy. Exact height adjustment gives your timber the right dimensions.
- ✓ Log beds with lifting winches, which can together stand the load of one metric ton.
- ✓ Choose an electric or a petrol-driven chainsaw; both the options can be supplemented with a log moulder.
- ✓ Easy to transport, store and maintain. Durable, dirt-repellent surface. It never rusts.
- ✓ The sawmills can be upgraded when you require more capacity.
- ✓ Always a good working position. The log comes at a comfortable level thanks to the integrated winches.
- ✓ A wide range of chains and guide bars – easy to order and quick deliveries.

SAWMILLS model comparison

BAND SAWMILLS

The Logosol line of band sawmills are of high quality and stand up well to the competition with other band sawmills on the market. We give you a 2-year warranty and 60 days money-back guarantee.

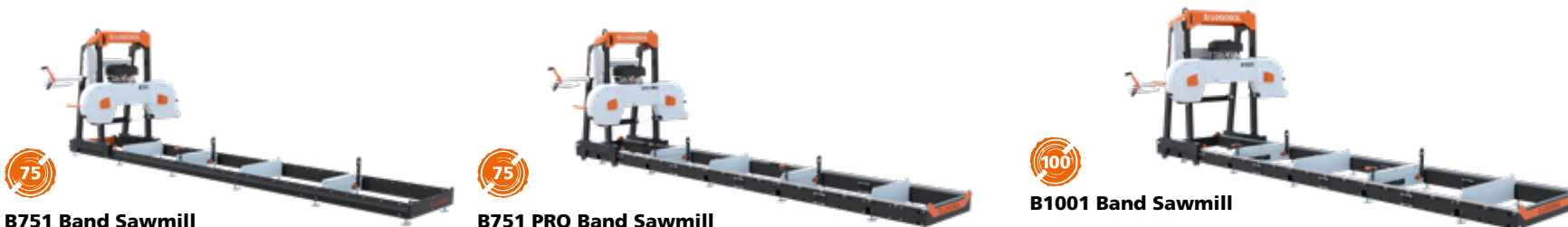

Weight	423 kg	464 kg	630 kg
Length	5.75 m	5.85 m	5.86 m
Width	1.975 m	2.25 m	2.34 m
Effective sawing length	4.8 m	4.8 m	4.85 m
Extensions	Can be extended with 1.14 m sections	Can be extended with 1.15 m sections	Can be extended with 1.15 m sections
Log diameter	Up to 75.1 cm	Up to 75.1 cm	Up to 100.1 cm
Wheel diameter	50 cm	50 cm	50 cm
Cant width	Max. 60 cm	Max. 60 cm	Max. 85 cm
Motor options	Petrol engine, 13 or 18 hp. Electric motor 4.6 or 8 kW. Log moulder (LM410).	Petrol engine, 18 hp. Electric motor, 8 kW. Log moulder (LM410).	Petrol engine, 23 hp. Electric motor, 12 kW. Log moulder (LM410).
Included	Band blade, levelling feet, adjustable blade guides, log clamp, water cooling, 2 short log supports.	Band blade, levelling feet, adjustable blade guides, 2 log clamps, water cooling, 2 short log supports, 2 long log supports.	Band blade, levelling feet, adjustable blade guides, 2 log clamps, water cooling, 2 short log supports, 2 long log supports.
Accessories	Protective cover, extra log clamps, extensions, manual toe board, extra pair of log supports, and more.	Trailer kit with support legs, Smart Set, log handling package, protective cover, extra log clamps, extensions, hydraulic toe board, extra pair of log supports, and more.	Trailer kit with support legs, Smart Set, log handling package, protective cover, extra log clamps, extensions, hydraulic toe board, extra pair of log supports, and more.

Advantages of the Logosol band sawmills

- ✓ High capacity and great sawing yield. You can upgrade the sawmill as your business grows.
- ✓ Quick and exact adjustment of depth-of-cut, the sawhead is adjusted in exact steps.
- ✓ Choose between electric motor or petrol engine. It can also be equipped with a log moulder.
- ✓ Robust and well thought-out. The stable design gives you an amazing sawing result.
- ✓ Easy to set up. It comes with a partly preassembled sawhead and a detailed manual. Levelling feet are included.
- ✓ You are spared from walking in sawdust. The wheels have fan blades, which both blow sawdust away from the working site and keep it clean and tidy inside the sawhead.
- ✓ Exact blade guiding, which you usually only find on considerably bigger and more expensive sawmills.
- ✓ A wide range of band blades – easy to order and quick deliveries.

LOG MOULDING



The sawmill becomes a log house factory

With a log moulder you can produce timber for log houses on your sawmill. Produce timber to order or for your own projects. For our log moulders, there are several different moulding knives that can create all possible log profiles.

We have long experience of log moulding

Take a course to learn the basics

Log moulder packages to suit every pocket



Many people dream of a log house, and the market for unique solutions is big. Offer your customers turnkey cabins. Or why not building your own dream house? Take a course in log house building at Logosol to learn the basics.

From log to log house with log moulders from Logosol



In our range of products you find log moulders and planer/moulders for all projects. From production of plank timber for a small garden cabin, to efficient production of timber for log house manufacturing.

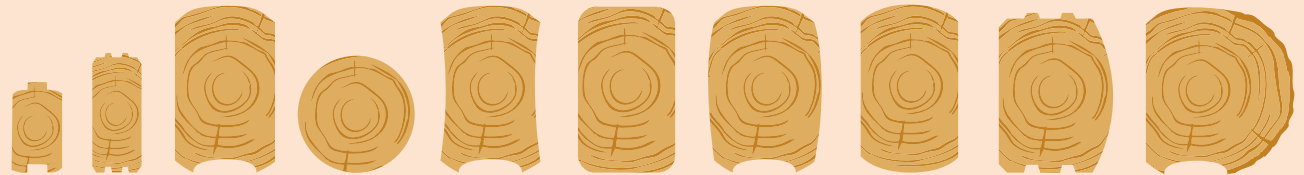

No matter what log profile you want to use in your project, we have the machines and the equipment that help you fulfil your dreams.



Log moulding on chain sawmills with the LM230

Equip your chain sawmill with the Logosol Log Moulder, and produce large amounts of timber for building log houses. Quickly and easily you mill both the top and the bottom of the cant. Knives for producing log house timber are available from 3 to 6 inches. Available with electric motor and as a model powered by a chainsaw.



Available both with electric motor and as a model powered by a chainsaw (Stihl MS661).

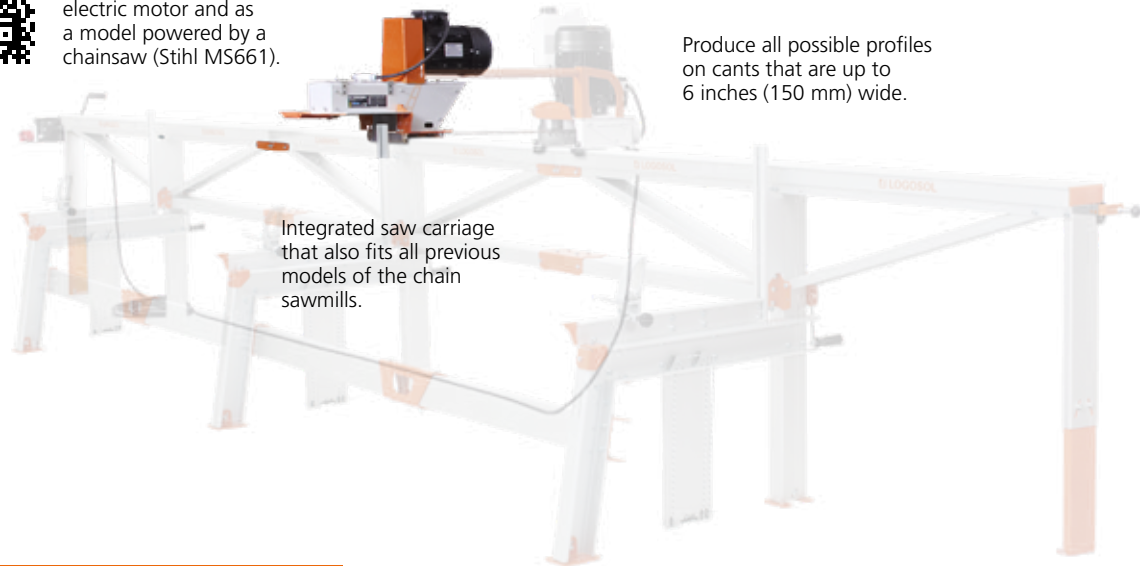

Produce all possible profiles on cants that are up to 6 inches (150 mm) wide.

Integrated saw carriage that also fits all previous models of the chain sawmills.

Also compatible with all previous models of Logosol's chain sawmills



Technical data: LM230 log moulder

- Motor:** 4 kW electric motor or a Stihl chainsaw MS661.
- Cutter head:** 210 mm wide with 4 slots for moulding or planing knives
- Max. knife protrusion:** 25 mm
- Log moulder knives:** from 3 to 6 inches
- Weight:** 35 kg

7700-000-0230	LM230 for chainsaw, crank as motive force	
7605-000-1230	LM230 4 kW, crank as motive force	
7605-000-1235	LM230 4 kW, for electric/manual feed unit	
7000-002-5237	Log moulder knife set, 3" (75 mm)	
7000-002-5242	Log moulder knife set, 4" (100 mm)	
7000-002-5212	Log moulder knife set, 5" (125 mm)	
7000-002-5202	Log moulder knife set, 6" (150 mm)	

Log moulder packages for F2/F2+

F2 with LM230

Suitable when you are going to build garden cabins or make garden decoration. Can be extended to desired length.

4525-555-9230	F2, 4 m, MS661, LM230 petrol	
4525-555-9232	F2, 4 m, E4000, LM230 4 kW	

F2+ with LM230

Suitable when you are going to build your own house. Can be extended to desired length.

4530-555-9230	F2+, 7 m, MS661, LM230 petrol	
4530-555-9232	F2+, 7 m, E8000, LM230 4 kW	



A profitable niche

Many people dream of a log house, and the market for unique solutions is big. Offer your customers turnkey cabins. Or why not building your own dream house? Take a course in log house building at Logosol to learn the basics.

Log moulding on band sawmills with the LM410

The log moulder LM410 also works as a jointer/planer for beams of dimensions up to 800 x 800 mm. Available both with petrol engine and 3-phase electricity. The track width is adjustable and fits most makes of band sawmills, such as Logosol, Norwood, Woodmizer and Lennartsfors. Patented equipment facilitates the operation and gives a better result.



Planes up to 800 mm in width and 800 mm in height.

Adjustable to fit most rail frame widths and makes of band sawmills.

Stable construction that gives an amazing result.

Compatible with most makes of band sawmills!

LM410 fits these rail widths: 825-960 mm
LM410 XL fits these rail widths: 1014-1140 mm

Technical data: LM410 log moulder

Length: 720 mm	Max. planing height LM410 XL: 800 mm
Height: 1000 mm	CUTTER HEAD
Width: 1400 mm	Diameter: 72 mm
Weight: 195 kg	Width: 410 mm
Max. planing width LM410: 600 mm	Rotational speed: 6000 rpm
Max. planing height LM410: 600 mm	Max. take-off when planing: 7 mm
Max. planing width LM410 XL: 800 mm	Max. moulding knife protrusion: 25 mm

8000-000-0615	LM410 4 kW, compatible with B751/ B751 PRO and similar	
8000-000-0625	LM410 9 hp, compatible with B751/ B751 PRO and similar	
8033-000-0005	LM410 XL 4 kW, compatible with B1001 and similar	
8033-000-0025	LM410 XL 9 hp, compatible with B1001 and similar	
8020-007-5202	Log moulder knife set, 6" (150 mm)	
8020-007-5232	Log moulder knife set, 8" (200 mm)	
8020-007-5252	Log moulder knife set, D-log 6-8"	

Log moulder packages for B751/ B751 PRO and B1001

B751/B751 PRO with LM410

Suitable when you are going to build your own house, or produce and sell planed beams or wide slabs.

8200-555-0013	B751 13 hp 8 m, LM410 9 hp	
8200-555-0018	B751 PRO 18 hp 8 m, LM410 9 hp	
8200-555-0008	B751 8 kW 8 m, LM410 4 kW	
8200-555-0088	B751 PRO 8 kW 8 m, LM410 4 kW	

B1001 with LM410 XL

Suitable when you are going to build your own house, or produce and sell planed beams or wide slabs.

8300-555-0023	B1001 23 hp 8 m, LM410 XL 9 hp	
8300-555-0012	B1001 12 kW 8 m, LM410 XL 4 kW	

Timber with one rounded side (D-log)



The package includes:

Log moulder knife set, D-log 6-8" (150-200 mm), incl. gibs.

You can produce material for ready-made log cabins with unique detail solutions.

Sell ready-made cabins!

8020-007-5252



Log house building tools from Gränsfors Bruk



Gränsfors log house building and woodwork tools are specially designed for log house building and wood sculpting.

Old-days tools have served as models to the tools that are manufactured by Gränsfors today, but they have been modified and developed in cooperation with specialists and craftsmen to suit today's needs. All the axes are designed to suit a specific application.

9999-000-4801	Timber broadaxe, model 1900, straight handle, ground on both sides	
9999-000-4812	Timber broadaxe, model 1900, left-angled handle, ground on the right side	
9999-000-4822	Timber broadaxe, model 1900, right-angled handle, ground on the left side	
9999-000-0465	Carpenter's axe	
9999-000-0485	Mortise axe	
9999-000-0486	Draw knife	

Turn your chainsaw into a debarker and a milling cutter



Scan the QR code to watch a video on how to use the Log Wizard!

The tool that with a simple operation turns your chainsaw into an efficient planer, a milling cutter and a debarker.

You cross cut, debark, mill and plane whole logs and workpieces with one and the same equipment – your chainsaw. The log house builder gets a tool that easily can machine the timber when making corner joints e.g. The farmer gets help to point poles for the enclosed pasture and the sawyer saves chains or band blades by debarking and trim the log before sawmilling. Many people use the Log Wizard to debark the edges of un-edged boards. When installing the Log Wizard, you drill a hole in a guide bar and replace the chain to fit the sprocket of the milling cutter, which in its standard design has a chain pitch of 0.325" or 3/8".

- ✓ It fits all chainsaws with a chain pitch of 0.325" and 3/8".
- ✓ It cleans the timber from gravel and sand.
- ✓ It removes bark from logs and un-edged boards.
- ✓ It mills notches for corner joints in log house timber.
- ✓ Suitable for making grooves and carvings.
- ✓ Cutter head and chain guard are included.

Technical data: Log Wizard

Weight: 2 kg
Working width: 80 mm
Number of rotating knives: 2
 Can be used on most chainsaws on the market.

9999-300-0187	Log Wizard	
---------------	------------	--



The cowboy house became a success

A Log Wizard from Logosol was the solution when a large amount of logs had to be debarked. Dick Bewarp's house-building project became a TV show in Sweden. Viewers of all ages seated themselves in front of their televisions to watch Dick building a home in cowboy style. After having debarked 300 logs, he can only state that without the Log Wizard debarker, he would never have been able to pull the project off.



WIDE SLAB SAWMILL



BIG MILL:

It's no problem to cut up a log as big as this when you have the right equipment.

Sven-Olov Larsson

Logosol Big Mill

You can come across really big trees both out in the woods and in older parks and gardens. When the trees are felled, it is often hard to find the right tools for cutting the logs into valuable boards. Oversized logs are easiest to cut up on the spot where they were felled, and the Logosol Big Mill is the ultimate solution. The package consists of a saw frame for big chainsaws and guide rail sections, which give stability and highest precision.

The ultimate system for wide slabbing

Cut oversized logs with great precision

Comfortable, exact and safe sawing



Now, you can easily produce wide, rough-edged boards from different sorts of fine wood. You get unique end products with a high value.

From oversized log to unique boards with the Logosol Big Mill



Fit the guide rail assembly to the log, where you want to make the first cut. Then mount the saw frame, which slides easily on the guide rails.



The saw frame is driven forward by a crank. Working with this method is easy, and it gives a stable and even pressure through the log.



After each saw cut, you lower the guide rail assembly and the saw frame. Included saw templates make it easy to set the dimensions for the next board.



The log is now cut into valuable, unique boards with exact dimensions. The equipment can handle logs that are up to 180 cm i diameter.

LOGOSOL BIG MILL wide slab sawmill

New possibilities for giant logs

Giant logs are easiest to cut up on the spot where they were felled. The Logosol Big Mill is a complete equipment package that gives you unique opportunities to make use of valuable giant logs. Cut wide, rough-edged boards from different sorts of fine wood. The system with two guide rails gives stability and highest precision. You work quickly and safely in a comfortable working position. After some practice, you will only need a couple of minutes to set the equipment for the next cut. This sawmill can handle log lengths up to 2.7 metres and diameters up to 180 cm. You can extend the equipment for longer logs.



Comfortable operation with a crank that gives an even pressure and a very good sawing result.

Guide bar lengths of up to 84" (214 cm) allow for a cutting width of fully 180 cm. Longer guide bars can be specially ordered.

Chainsaw is sold separately.

Simple setting between the saw cuts.

Safe, efficient and exact sawing.

2.7 metre sawing length with the possibility of extension.

Separate oil pump for lubrication at the bar nose, means minimal wear on the guide bar.

Water cooling of the chain makes the chain stay sharp longer.

Two guide rails give stability and accurate measurements.

Tools for changing chain and templates for exact setting for different board thicknesses are included.

Technical data: Logosol Big Mill

Weight: 41 kg (saw frame: 26 kg, rail assembly: 15 kg)
Length: 2x3 metres as standard. Easy to extend.
Max. log diameter: Up to 180 cm, with the possibility of sawing even larger logs.

Guide bar length: 142, 166, 214 cm
Recommended motor power: Approx. 9 hp. We recommend the Stihl MS880. It can also be equipped with Logosol's electric saw unit ES8.

5000-000-0002	Big Mill, 56" (142 cm), incl. guide bar and chain	
5000-000-0003	Big Mill, 66" (166 cm), incl. guide bar and chain	
5000-000-0004	Big Mill, 84" (214 cm), incl. guide bar and chain	
1124-011-3016	Stihl MS880	
4920-000-0010	ES8 modified for Big Mill	



We have developed the best system you can find on the market for wide slabbing giant logs with a chainsaw. With the Big Mill you can saw comfortably and safely, on the spot where the log was felled"

Bengt-Olov Byström, founder of Logosol





The Logosol Big Mill is the ultimate solution for sawing giant logs on the spot where they were felled. You can make wide cuts that are millimetre accurate through the whole log.



Special guide bars and chains for Big Mill

Logosol has long experience in chain sawing. We have a complete range of double-ended guide bars and ripping chains specially adapted for sawing with the Logosol Big Mill.

		Sawing width	
3010-056-0143	Guide bar 56" (142 cm)	110 cm	
3671-000-0153	Chain for 56" guide bars		
3010-066-0168	Guide bar 66" (167 cm)	135 cm	
3671-000-0177	Chain for 66" guide bars		
3010-084-0214	Guide bar 84" (214 cm)	180 cm	
3671-000-0220	Chain for 84" guide bars		

The powerful Stihl MS880 does the job!

For the Logosol Big Mill, we recommend the Stihl MS880. It is one of the strongest chainsaws on the market with an engine power of 8.6 hp and a weight of 9.9 kg.



1124-011-3016	Stihl MS880, without bar and chain	
---------------	------------------------------------	--

Big Mill saw frame



The saw frame stabilizes the guide bar. On the top of the saw frame there are functions such as, water cooling and separate oil pump for effective lubrication of the chain. On the chainsaw side there is a saw carriage with a crank for comfortable and even feeding forward.

Can easily be extended!



Big Mill guide rail package

With the guide rail package for the Big Mill you get highest precision and exact measurements in every saw cut. Very simple adjustments between the saw cuts. The standard length of the guide rails is 3 metres, but it can easily be extended to the desired length.

Guide bar adjuster



A long guide bar tends to hang down when it is supported at both ends. A quick and easy way of straightening the guide bar is to use the guide bar adjuster.

4920-001-0480	Guide bar adjuster	
---------------	--------------------	--

Guide rail prop, accessory for long guide rails



A useful tool when you need to support the guide rail. Should be used when the guide rail is extended to a length longer than 3 m and always when you are sawing with an electric saw.

4920-001-0475	Guide rail prop for Big Mill	
---------------	------------------------------	--

Vertical bars

For the Big Mill saw carriage. Should be used when the slabs are really thick or when you want to split the log through the heartwood.



4920-001-0016	Vertical, price per unit	
---------------	--------------------------	--



ULTRA-PORTABLE SAWMILL



A complete system for log sawing

Great freedom to cut timber where the trees are

Turn your chainsaw into a mini-sawmill

Good results at once!

The Logosol Timberjig is part of a well thoughtout system that can easily be expanded and upgraded when required. For a small investment you get an ultra-portable sawmill that cuts with great precision. With this equipment you can handle everything from small to oversized logs. You get good results at once and get quickly started with your sawing project!

With the Logosol Timberjig you saw quickly and accurately for a small investment, in the place where you are and where you need it.



TIMBERJIG:

As a grandfather, I have been hit by the sawing virus. I'm planning to build both a playhouse and a sandpit for my grandchildren.

Ralf Stehle

From log to board with the Logosol Timberjig



Fit the guide rail and its holders directly to the log. Install the Logosol Timberjig on the chainsaw. Now it's time to saw timber!



The first cuts are sawn with the help of the guide rail. Exact angles and fixed steps for width and thickness ensure simple setting.



When three sides of the log are cut, you can start sawing your planks and boards. The guide rail ensures great precision through the whole log.



You can also remove the guide rail and its holders. You then use the Timberjig directly on the cant. The board thickness is steplessly adjustable.

TIMBERJIG ultra-portable sawmill

A complete system for cutting boards with your chainsaw

The Logosol Timberjig turns your chainsaw into an ultra-portable mini-sawmill. The equipment is easy to carry and simple to use. Stable guide rail holders and height adjustment in exact steps facilitate work and give your timber the right dimensions. You get a good result at once, with impressive precision. This sawmill can handle logs that are up to 2.7 metres long and 60 cm in diameter. If you are going to cut larger logs, the equipment can be extended. With the Timberjig ultra-portable sawmill, you get a flexible system with all functions needed for saving your own timber where the trees are. The equipment is compatible with most chainsaws. Use your own or buy one from Logosol. We recommend Stihl MS391 or MS661.



It can handle logs that are up to 60 cm in diameter. If you are going to cut even larger logs, the system is expandable up to 135 cm in log diameter. Visit the website for more information.

Chainsaw and cutting tools are sold separately.

It fits most chainsaws.

The rigid guide rail of aluminium ensures straight cuts every time.



Stable rail holders with exact adjustment steps make sawing easy.

Technical data: Logosol Timberjig with guide rail package



Weight: 15 kg

Length: 3 metres as standard. Easy to extend.

Capacity: 2-3 logs per hour.

Max. log diameter: Up to 60 cm, with the possibility of

cutting even larger logs.

Recommended bar length: 40-63 cm

Recommended motor power: At least 4 hp.

4900-000-4000

Logosol Timberjig with guide rail package



Many who use the Logosol Timberjig are impressed by how well it works. Your chainsaw becomes a complete mini-sawmill!"

Mattias Byström,
Vice president





 **EXPANDABLE FOR EVEN LARGER LOGS**
 The Logosol Timberjig is expandable, so you can cut single logs that are up to 135 cm in diameter. Visit the website for more information.



Many fields of use

- ✓ A hunting lookout in the woods
- ✓ Simple benches and tables
- ✓ Woodwork in your garden
- ✓ A garden shed or a sauna
- ✓ Joinery materials
- ✓ Cladding boards



Compatible with most chainsaws

We can supply you with chainsaw, guide bar and chains that are adapted for log sawing, but you can also use standard equipment if you already own a chainsaw with two guide bar bolts. We recommend Stihl MS391 or MS661 when you are sawing with the Logosol Timberjig.

Read more about our chainsaws on page 12.



Can easily be extended!

Guide rail package for the Logosol Timberjig

With the guide rail package for the Logosol Timberjig, you get high precision and exact measurements in every saw cut. The guide rail package consists of two rail holders of steel and three 1-metre-long guide rail sections of aluminium. The package allows easy transport and storing. **Recommended!**

Guide rail prop, accessory for long rails

Should be used when the guide rail is extended to a length longer than 3 m. Compatible with Timberjig and Big Mill.



Logosol Timberjig

Attach it with the two guide bar bolts of the chainsaw. The Timberjig can be used without the guide rail package, if you build your own guide rail of wood for making the first cut. However, to get the best result when sawing, we recommend that you use the guide rail package.

4900-000-1000	Logosol Timberjig
---------------	-------------------

4900-000-4005	Logosol Timberjig guide rail package
---------------	--------------------------------------

9999-000-1026	Guide rail prop
---------------	-----------------

LOGOSOL C210 board edger

Efficient sawing with a separate board edger

With a separate board edger the sawyer gets a machine that efficiently cuts away rough edges of the boards. The board edger C210 significantly increases your capacity, no matter if you cut boards with a band blade or a chain. You get more out of the log and save time. This machine is easy to use; you get started with just a few simple steps. Set the desired width and send the timber through – quickly and safely!



Easy setting of the desired sawing width.

Two circular sawblades for an accurate result.

In- and out-feed tables are standard.

A strong feeder holds and pulls the board through the machine during the cutting operation.

The design, with one sawblade coming from above and one from below, gives you an exceptionally safe operation.

You can edge boards of any width. The open side allows unlimited board width.



Included with the Board Edger C210

- ✓ In- and out-feed tables
- ✓ Circular sawblades with carbide teeth

Technical data: C210 board edger

Max. width of workpiece: Unlimited
Edging width: 30-210 mm
Height of workpiece: 13-35 mm (recommended max. height 30 mm)
Feed rate: 10 m/min*
Weight incl. machine stand: 240 kg
 *Can be customized according to your requirements.

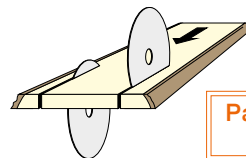

Patented sawing solution!

A safe investment!

- ✓ Compact. Has all the advantages you otherwise only find in significantly larger and more expensive board edgers.
- ✓ Safe. Sawblades and feed rollers are covered. The unique design gives a controlled sawing process.
- ✓ Can be run with or without sawdust extractor. Machine stand, sawdust chute, hose and sawdust extractor are available as optional attachments.
- ✓ The board edger is open on one side of the machine table. This unique design means that there is no limit to how wide boards you can feed in.
- ✓ Equipped with a smart fence, the C210 can cut battens or laths (1" or 2" wide). It can also be used for resawing already edged boards.

5220-000-1000	Board edger C210	
5220-001-0500	In- and out-feed tables, 2.3 m (price/table)	
5220-001-0300	Sawdust chute kit	



A board edger increases your capacity, no matter if you own a chain sawmill, a band sawmill or a circular sawmill.

Greater yield with a board edger

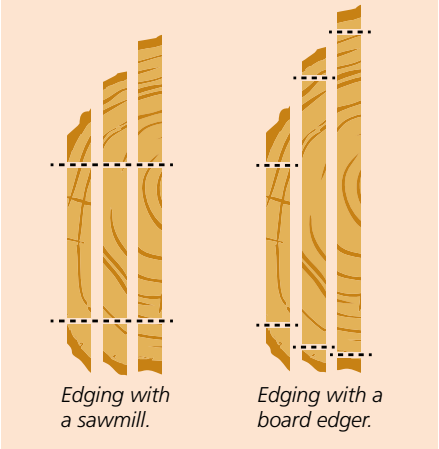

From rough-edged boards to finished timber



You operate the three motors of the machine from the control panel.



Set to the desired width by using the clear scales for easy adjustment.



Two circular sawblades cut fast and straight.



The side cover is opened by the workpiece when you are edging extra wide boards.



The board is edged in a quick and controlled operation.



Efficient cutting at an unbeatable price

With Logosol's stack cutter you cut the whole timber stack at once. Just adjust it to the desired length and let the stack cutter do the job – quickly and efficiently with very high accuracy. The stack cutter takes the cut linearly vertically, a method that gives you increased capacity and flexibility. This machine is already appreciated by many who cut timber stacks. The 150 cm long guide bar is guided at the bar nose. The chain is a standard cross-cutting chain driven by a strong electric motor. The stack cutter does not take up a great deal of space, and it runs easily on its sturdy castors. The included measuring tape helps you measure the length of the stack. Many simple stack cutters fold the guide bar down through the timber stack. Vertical cutting is used by Logosol's stack cutter and by significantly more expensive, professional stack cutters.



Easy to use. The timber stack does not have to lie completely level before you make the cut.

The ball-bearinged bar nose guide steers the bar in an exact line from the top down.

Aiming arm for positioning of the cut.

Standard cutting equipment with 3/8" chain pitch means low operating costs.

Big castors make the stack cutter easy to move.

You cut 1.5 m x 1.5 m stacks with a precision of +/-2 mm.

Profitable even at low volumes

- ✓ It cuts with great precision for a small investment. You get the same accuracy as from considerably more expensive machines. Profitable even at small volumes.
- ✓ Easy to work with. The controls are at working height and a Plexiglas shield stops the sawdust. Easy to set up.
- ✓ Easy to store. The portal-shaped design of steel, and three big castors give you a mobile stack cutter with a small footprint that can easily be moved.

Max. power output: 10 kW.

Automatic oil pump.

Stable steel structure gives straight cuts.

You adjust the guide bar and the vertical angle by a crank.

Advantages of vertical cutting:

- ✓ Fine sawn surface
- ✓ You can cut larger timber stacks
- ✓ Low costs of cutting equipment



The stack cutter is shipped unassembled. Guide bar and chain are sold separately.

8530-000-0150	Logosol PK1500	
3002-001-8076	Guide bar 150 cm	
3673-000-0189	Saw chain	
8530-555-0150	Ready-to-start package incl. PK1500, 150 cm guide bar and saw chain	



Technical data: PK1500 stack cutter

Max. dimensions with a 150 cm guide bar	Weight: 145 kg
Width: 1450 mm	Cutting equipment
Height: 1450 mm	Chain pitch: 3/8 inch
	Chain speed: 22.5 m/sec.
Machine dimensions and weight	Electrical system
Length: 2600 mm	Electrical supply: 3 phase, 400V, 16A
Height: 1900 mm	Motor: Rated power 5 kW
Width: 1100 mm	



When you are cutting, the electric motor is protected by temperature sensors.

The guide bar, which is guided at the bar nose, cuts linearly vertically.

Accurately cut timber packages with the Logosol Stack Cutter



Set it up, and then press the start button. The long guide bar cuts fast and accurately.



Between the cuts you move the package with a standard pallet jack.



Timber packages of impressive accuracy ready for shipping!



We are experts at stack cutting. Call us and we will tell you more!

 **LOGOSOL WDU** complete wood drying

Never before has it been so easy to get perfectly dried timber

For joinery you need dry wood. Mouldings, furniture, floors and windows are examples of when the dryness of the wood is particularly important. Preferably, the wood should have a moisture content down to, or even below, 10% and have no cracks. This can be hard to achieve by traditional air drying. With your own drying kiln, you produce perfectly dried, valuable joinery timber in a few weeks.



Powerful fan action for effective circulation in your drying chamber.

Integrated air intake.

Perfect together with the Logosol Drying Chamber that has a top valve for controlling how quickly the steam is let out.

Uniform and controlled drying result.



Loading in wood is easy thanks to the big opening.

Perfectly dried, valuable joinery timber in a few weeks. Within a week you will have dried pine timber ready to be planed and moulded.

Energy-efficient drying with a perfect result. You get less cracks and warping compared to air-dried timber.

The drying chamber together with the drying unit only weighs about 50 kg; it can easily be moved by two people.

Technical data: WDU wood drying unit and drying chamber

WDU

Power: 2.2 kW

Electrical supply: 230 V, 10 A

Height: 545 mm

Width: 315 mm

Depth without motor: 125 mm

Depth with motor: 275 mm

Weight: 8.7 kg

Drying chamber

Height: 1.5 m

Length: 3 m

Depth: 0.7 m

Timber volume: 2.6 m³

Weight (WDU and drying chamber): approx. 50 kg

More efficient WDU Drying Unit gives you more control

The upgraded Sauno drying unit of 2 kW has a significantly more powerful fan action for air circulation in the drying chamber. The new unit also has an integrated air intake that draws air into the dryer by means of the underpressure formed in the air stream. The dry and cold outside air is mixed with the heated, moist air in the Sauno drying unit before reaching the wood in the chamber. These are features that give a more uniform and controlled drying result.

6200-000-0000	WDU drying unit	
6200-555-0000	WDU drying unit incl. drying chamber	

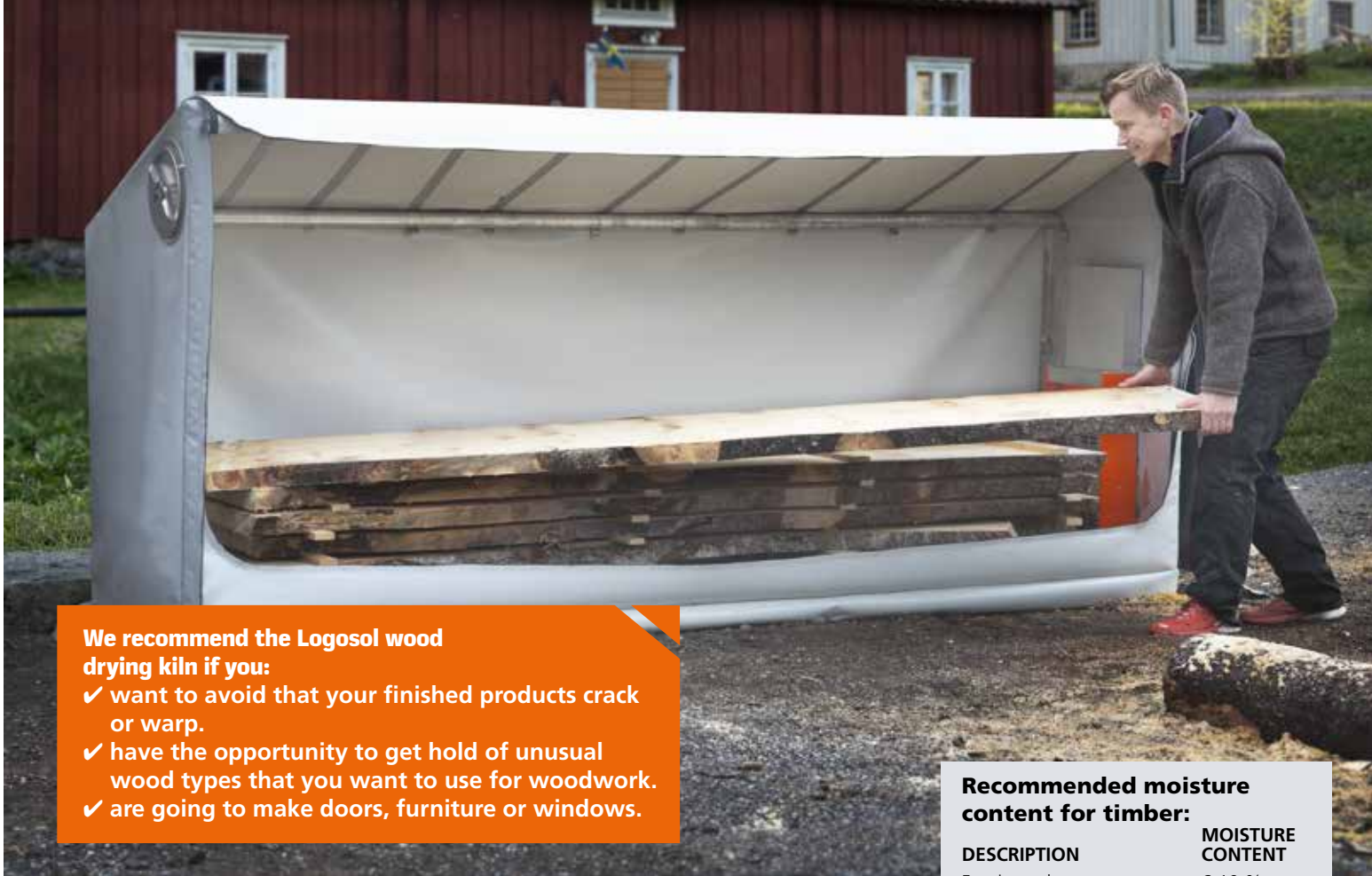

We recommend the Logosol wood drying kiln if you:

- ✓ want to avoid that your finished products crack or warp.
- ✓ have the opportunity to get hold of unusual wood types that you want to use for woodworking.
- ✓ are going to make doors, furniture or windows.

Recommended moisture content for timber:

DESCRIPTION	MOISTURE CONTENT
Furniture-dry	6-10 %
Room-dry, joinery-dry	10-15 %
Gluing-dry	14 %
Planing-dry	15-19 %
Air-dry (shipping-dry)	15-23 %

Drying chamber – dry your wood quickly and easily



Logosol's drying chamber is a smart solution with a soft, insulated cover that is supported by an internal, rigid aluminium structure. The drying chamber retains the hot and moist air during the initial drying phase. If the drying chamber is installed outdoors, which we recommend, you use a two-layer solution, with a protective outer tent. The drying chamber together with the drying unit only weighs about 50 kg, so two people can easily move it. The top valve of the drying chamber, with graduated opening positions, controls how quickly the steam is let out.



Measure the moisture content with Stihl

Professional moisture meter from Stihl. If you are going to paint outdoors, it is vital that the timber has the right moisture content. With the moisture meter you get the answer quickly. It can also be used on cement and plaster.



0464-802-0010 | Stihl moisture meter



Logosol app for drying

In 2020, Logosol will launch an app for wood drying, Logosol Connect. By entering some values, such as sort of wood, thickness, volume and outside temperature e.g., you get instructions on how to set the dryer and a forecast for when the wood will have dried to the desired percentage.

The app is an interactive system, which allows everyone who uses the drying chamber to enter their actual values. The constants of the mathematical calculations are thus continuously updated, making the drying instructions and forecasts relatively accurate. The app is easy to use and makes you a drying expert right away.

Do you need a wood drying kiln?

- Woodworkers and joiners**
- ✓ Do you need furniture-dry wood?
 - ✓ Do you want to prevent your woodwork from cracking or warping after it is finished?
 - ✓ Do you have the opportunity to get hold of unusual sorts of wood that you want to use when doing woodworking?
- Small-scale sawyers**
- ✓ Do your customers ask for timber with a moisture content of under 18%?
 - ✓ Do you want shorter delivery times?
 - ✓ Should the wood have a more uniform moisture content?
 - ✓ Do you want tension- and crack-free wood?



Smart log-handling tools that give you extra strength

Logosol's unique tools for log handling give you extra muscles and a firmer grip. You work more efficiently and get a safer worksite, no matter if you work at your sawmill, out in the woods or in your own garden. These tools are easy to use and spare both your back and shoulders.

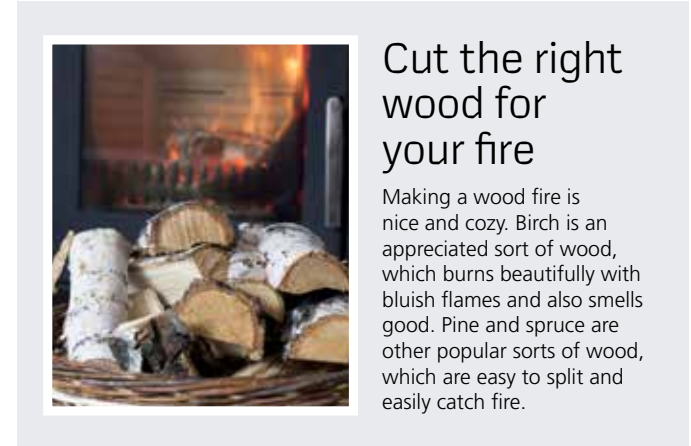

Cut the right wood for your fire

Making a wood fire is nice and cozy. Birch is an appreciated sort of wood, which burns beautifully with bluish flames and also smells good. Pine and spruce are other popular sorts of wood, which are easy to split and easily catch fire.



Ram it in and lift!



SMART SAPPIE

Extend your arm

The **Smart Sappie** is a tool inspired by the strong arms of the praying mantis. It holds, pulls and turns with good reach. Perfect for lifting objects from the ground. A remarkably useful gadget that spares your back when you are working out in the woods, in the fields, and in the woodyard.

9999-000-2710



Spare your back!



SMART TURNER

Roll and turn the log

The **Smart Turner** is the perfect tool whenever you are going to roll or turn a log. You keep the log in a firm grip through the whole process, which makes it impossible for the log to roll back when you take a new grip. Patented and awarded! Also useful when you are working at the sawmill.

9999-000-2702



SMART PUSHER

Fell and lift the tree safely

1. When felling trees. Ensures that the tree falls in the planned direction. **2. Lifting aid when handling logs.** It can also be used as a timber winch when loading timber, for example. An unbeatable tool! Length in starting position: 127 cm. Length of stroke: 95 cm. Max. load: approx. 500 kg.

9999-000-0565



The Smart Line products are good tools to get the logs in place when loading them onto the sawmill. Use the Smart Pusher as a timber winch when loading the timber and rotate the logs with the help of the Smart Turner.



Lifting hook with many smart functions!

SMART HOLDER

Holds the log while you're cutting

With the Smart Holder you can cut up branches and smaller logs in a safe way. The sawhorse holds the log by leverage during the whole operation. It can handle logs that are up to 225 mm in diameter.

- ✓ Easy to fold
- ✓ You can handle the job on your own

6101-000-1020

SMART SPLITTER

Splits the wood safely

With the Smart-Splitter you split the firewood quickly and easily. This wood splitter spares your back and shoulders and is safe for everyone to use.

- ✓ It splits the wood with great force
- ✓ It can handle really big chunks

6101-000-1010

SMART HOOK

A great lifting hook!

The ergonomic combination tool Smart Hook has a handle that is safe and easy to grip. The wedge-ground edge enables you to enter the saw kerf easily, if you want to prise the board loose. Super sharp edge.

- ✓ Lightweight
- ✓ Ergonomic handle

9999-000-2720



PLANERS

New planer line coming in 2021!
Keep updated on our website!



**Guaranteed
profitability from
day one**

**Pro equipment
for big and small
projects**

**Wide range of
moulding knives
& tools**

Profitable processing

In every board valuable mouldings and panels are hidden. With Logosol's planer/moulders you produce professional building materials, for your own renovations or to order. We offer you stable machines with a small footprint and at the right price. Our range is suitable for both the hobby-joiner and the wood processing company.



Make your own mouldings and panelling!



Profitable processing for your own consumption & for selling



Plan your business with LOGOSOL – we have the machines and the tools you need!



PLANERS cutting tools

Everything for your planer

All of Logosol's planer/moulders come with planing knives in all cutters. In the tool catalogue you find moulding knives and other cutting tools, both for the top, bottom and side cutters. We have a wide range of both special and standard knives. Choose exactly what you want and we promise you a quick delivery!



You find all cutter heads, gibs and planing and moulding knives in the tool catalogue. Free download on logosol.com

Choose the right quality of your cutting tools!

High Speed Steel (HSS): Suitable for normal planing and moulding.

Hard Metal (HM): Suitable for demanding planing and moulding of teak and other types of hardwood.



TIP! Try the search feature "Find your cutting tools". Available in our e-store!



CIRCULAR SAWBLADES

Sawblades for the combination machine SH410

Circular sawblade of hardened steel. Teeth of carbide.



7504-001-0008	SH410 225 x 35 x 2.8 mm, 16 teeth	
7200-000-1300	SH230, 180 x 48 x 2.8 mm, 14 teeth	
7200-000-1301	SH230, 180 x 48 x 4.5 mm, 14 teeth	



For top and bottom horizontal cutters

PLANING KNIVES



For top and bottom cutters

Sharpenable planing knives of two qualities. Choose HSS for normal planing and HM for more demanding material, such as teak, e.g. (HM-quality item no: 7000-003)

Ref. no.	mm	HSS
7000-002-8410	410	
7000-002-8330	330	
7000-002-8300	300	
7000-002-8230	230	
7000-002-8510	510	

INDEXABLE INSERTS

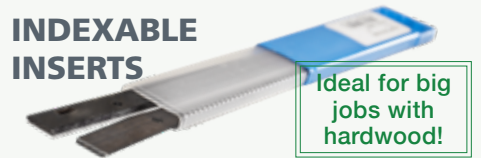

Ideal for big jobs with hardwood!

For top and bottom cutters

Extra durable knives of High Speed Steel (HSS). Indexable, not sharpenable. Equip your planer with indexable inserts as planing knives when you need to change to sharp knives quickly, without sharpening or resetting.

241-053	2 HSS indexable inserts 410(L) x12(W)x1.5(H) mm, top cutter	
241-054	2 adaptors for indexable inserts, 410mm, top cutter	
260-053	2 HSS indexable inserts 300(L) x12(W)x1.5(H) mm, bottom cutter	
241-055	2 adaptors for indexable inserts, 300 mm, bottom cutter	

KNIFE GIBS

Mounting of moulding knives

For moulding knives in the top and bottom cutters.



7000-000-9502	Standard gib, price/pair	
7000-000-9506	Adjustable gib, price/pair	

MOULDING KNIVES

For top and side cutters

Sharpenable moulding knives of two qualities. Choose HSS for normal machining and HM for more demanding material. Available in the widths of 40 mm, 50 mm, 60 mm, 100 mm (only for top cutters) och 130 mm (only for top cutters).

Visit our website for more information!

Let your creative juices flow – endless possibilities with moulding knives!



- ✓ All types of mouldings
- ✓ All types of casing
- ✓ Different kinds of bevelling
- ✓ Panelling
- ✓ Cladding



- ✓ Material for a hot tub
- ✓ Sauna panelling
- ✓ Round rods
- ✓ Joists and decking
- ✓ Tongue and groove



- ✓...and much more!
- Plane and mould for your own consumption or offer your customers wood profiles according to their requirements!

We are experts at small-scale wood processing. You are welcome to call us to find out more!

Design your own profile – affordable special knives!

Many customers look for special profiles, and this can become a profitable niche for your planing business. We will help you order custom-made knives, so you can offer your customers unique solutions at a reasonable price.



Sample pieces of old mouldings. We make custom-made knives to suit your requirements!



Price example: 1 pair of knives, total price:



Price example: 3 pairs of knives, total price:

Example of profiles sent in to us, which we then have used for producing special knives!

It is easy to place your order:

1. You send us a sample piece of the moulding by post or email a drawing.
2. We will contact you and give you a quotation.
3. After you have approved the quotation, the knife will be sent to you within 10 days.

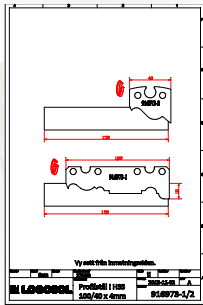

Example of a drawing of special knives.

Please contact Logosol for more information!



TIPS! Use the design of old moulding profiles and start selling.



Price example: 3 pairs of knives, total price:



Recreated royal mouldings

When the Amalienborg castle in Denmark needed to be renovated, Pål Davidsson's special joinery company was contacted. He received sample pieces of the original mouldings, ordered custom-made knives and machined dense pine with his PH260. Today, the cornices are in place in the castle, hand-gilded with gold leaf.

Let the customer decide!

MOULDING KNIVES

filtering on the website

We guide you to the right knives for your needs at logosol.com

Be inspired and search among 900 knives and 300 combinations on logosol.com. You can easily filter by what machine you want to use the knife combinations in!

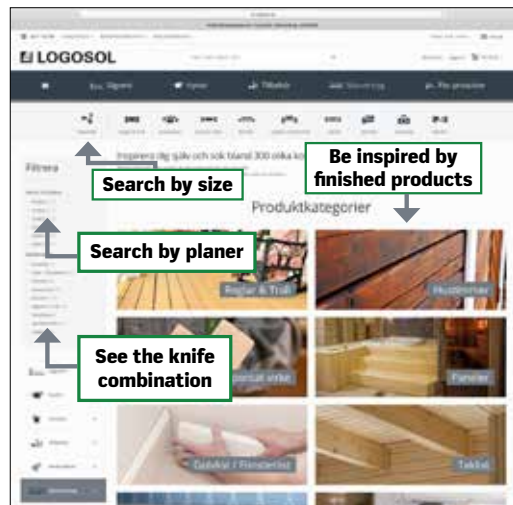
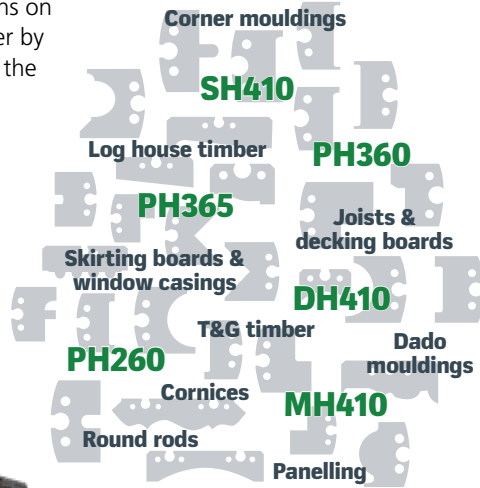

Search and filter by:

- ✓ Type of planer
- ✓ Combination of knives
- ✓ Type of finished product (joists, skirting boards, cornices, etc.)
- ✓ Size of the knife
- ✓ Name of the knife
- ✓ SKU number

We know all about profiling!

CHIP MANAGEMENT planers & joinery machines

Profit from a good chip set-up

You have a lot to gain from having a good chip set-up. Your machines will work more efficiently, and you get a better end result as well as a more pleasant working environment. Another good reason is that both shavings and sawdust have become products that people pay good money for, either as fuel or as litter for pet owners. Please get in touch with us if you want to adapt an installation to your particular machines, or if you are looking for more advanced systems.

RECOMMENDED FOR
SH230, MF30, MH410, H410

Chip extractor, 1.1 kW

Suitable when less wood debris is generated.



Technical data: Chip extractor 1.1 kW

Bag volume: 250 litres/bag
Inlet port: 125 mm (adaptor with 2x100)
Outlet port: 125 mm
Electrical supply: 1-phase 230V
Dimensions: 850(L) x 560(W) x 1860(H) mm
Weight: 46 kg

7000-000-2075

We know all about chip management. If you have any thoughts or questions, please contact us! Phone +46 611 18285.

FITS ALL LOGOSOL PLANER/MOULDERS



Chip hose

Strong and easy to bend. 100 and 125 mm.

TIP! When large volumes of wood debris is generated, it is good to have a 2.2 kW extractor!

RECOMMENDED FOR
SH410, DH410, MH410

Chip extractor, 2.2 kW

Three inlet ports for 100 mm hoses.



Technical data: Chip extractor 2.2 kW

Bag volume: 250 litres/bag
Inlet port: 150 mm (adaptor with 3x100)
Outlet port: Installed (square shaped)
Electrical supply: 3-phase 400V 16A
Dimensions: 1460(L) x 720(W) x 1860(H) mm
Weight: 59 kg

7000-000-2080

More products for chip handling are found in the e-store, www.logosol.com



Dust filter

Upgrade your chip extractor with a professional dust filter. Coarse filter of steel mesh, pleated microfilter of paper. The filter is 50 cm in diameter and 60 cm in height (excl. handle).

7805-001-0005

For 1.1 and 2.2 kW chip extractors

Higher quality gives better capacity!

- ✓ The stronger chip extractor the better.
- ✓ Place the exhaust outdoors, if possible, to reduce the dust levels.
- ✓ Cutter shavings are much sought after as fuel or stable litter!

7000-000-1013	3 m 100 mm	
7000-000-1017	6 m 100 mm	
7000-000-1019	12 m 100 mm	
7020-001-0130	Clamp, 100 mm	
7000-000-1021	3 m 125 mm	
7000-000-1023	6 m 125 mm	
7020-001-0135	Clamp 125 mm	

KNIFE GRINDER planer/moulders

TORMEK KNIFE GRINDER T-8

Always sharp knives!

Now you can always plane and mould with really sharp knives! The T-8 maximises the precision with its revolutionary solid-cast housing, which guarantees a minimal play for the universal support. This gives you the best conditions possible for a successful sharpening. Tormek's unique drive system is efficient and manages to maintain a constant speed, even under full load. The supplied Tormek original grindstone sharpens all qualities of steel, including HSS. The machine has many worked through details, such as quick locking of the stone with EzyLock, water trough with a lift and a removable magnetic scraper for effective cleaning. 7 years warranty.



There are more tools at www.logosol.com. If you have any questions, you are welcome to contact us on +46 611 18285!



Order our tool catalogue!

In the Logosol Tool Catalogue you find 92 pages of cutter heads, gibs, moulding knives, and other cutting tools. Available for free download on logosol.com.



Expert advice included!

If you have any thoughts or questions you are welcome to contact us on +46 611 182 85!



7010-000-1035

Included with the T-8

- ✓ Square edge jig
- ✓ Stone grader
- ✓ Truing tool
- ✓ Honing compound
- ✓ Angle measurer
- ✓ Handbook & DVD

This is why you should buy your planer from Logosol:

We have the knowledge and experience that enable you to produce exactly what you want. Our planers are amazing machines, but without the right tools you can't get the most out of your investment. Our sales-staff is ready to guide you to the right knives and profiles.

Jigs for the Tormek T-8



For planing knives

7010-000-1005



For moulding knives

7010-001-1012



For axes

7010-001-1014



For knives

7010-001-1011



For long knives

7010-001-1010



For scissors

7010-001-1022



Blackstone

7010-001-1020

Catalogues and handbooks

Download handbooks and catalogues, completely free of charge. Here you will find everything from the Tool Catalogue to the handbook on how you keep your cutting tools in trim.



Technical data and manuals

Download the manual for the machine you are interested in. At logosol.com you always find technical data, detailed pictures and information about each product.

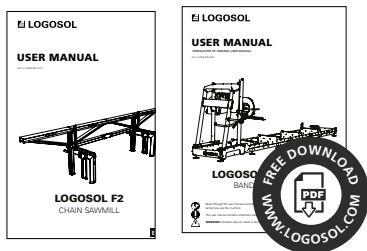

Subscribe to the e-newsletter

Get the latest news about products and campaigns directly in your inbox. LOGOSOL's e-newsletter has over 120 000 subscribers all over the world and we hope that you will appreciate our mailings. Sign up on logosol.com!

Trade shows and courses

On logosol.com you find dates for coming trade shows and machine demos. We also have a training programme with, among other things, courses in joinery and in building log houses. See this year's dates for training courses and sign up now!



Visit our own web magazine

We have received success stories from our customers for over 20 years. Now our customer magazine is available on the web. On woodworkingproject.com you find videos, the latest product news and many inspiring customer stories from all over the world!



See reportage videos on woodworkingproject.com!

Inspiration and deepening

Inspiration and real joy of wood. Product videos, manuals and technical data. On logosol.com you find everything you need to know about our tools and machines. Make a visit today, and download our popular handbooks and building instructions!



Saw video – learnt how to saw!

What is the best way to learn how to use a Logosol sawmill? "You watch Logosol's videos and start sawing," says Kjell Rogström, who bought his sawmill after having thoroughly watched the product videos that are available on logosol.com. Today, he cuts his own timber for his building projects, using an electric Logosol Sawmill.

Over 100 product videos

We have over 100 videos on our website, showing machines and accessories. Watch product videos about sawmills, planer/ moulders and joinery machines directly on your computer, your smartphone or your tablet.



Windows according to Logosol plans

David Torstensson wants to offer his customers unique products of high quality, and has produced his own building plans in cooperation with architects. But when it comes to windows, he builds according to plans from Logosol.

Free building instructions

Free download. For example, you get detailed instructions for building:

- outward opening windows
- a sledge or a rocking-horse
- a wood-burning sauna
- an outdoor hot tub





LOGOSOL e-store

Safe e-shopping

Shop in the e-store on logosol.com – your nearest department store for machines and tools within wood processing. Here you can see all campaigns and easily plan your purchase. Smart details, short cuts and search features facilitates when you are placing your order. You can do safe business in peace in front of your computer. You are welcome to come and shop at logosol.com!

- Web-safe applications protect your personal data.
- Your order is handled manually by our skilled sales staff. If you want to add to or change your order afterwards, you just give us a call.
- Create your own account. This way you can view order statistics and save items in your shopping cart for a later time.
- You do not have to fill in your billing or credit card information until you are ready to make your purchase.



Find a reference customer!

We have daily contact with customers all over the world, who fulfill their dreams of wood. Call +46 611 18285, and we will put you in contact with a reference customer near you!



LOGOSOL merch

A must for all "Logosolers"!

Cut timber in style

With a Logosol cap on your head you will quickly connect with other people who like to work with wood! Supplement with a useful folding rule and a knife. The selection may vary over the year.



9922-700-0001	Hoodie "Hard work, boards and sawdust"	
9922-120-0065	T-shirt "As I saw so shall I build"	
9922-700-0002	T-shirt "Ask me about my LOGOSOL project"	



Textile belt and buff

Textile belt and buff with saw chain pattern.

9922-700-0003	Textile belt	
9922-700-0004	Buff (can be used as a hat, a scarf, a bandana, a headband, etc.)	



Choose Logosol all year round!

Our Logosol caps are very popular. For colder days, choose our beanie!

9922-120-0000	Standard cap (black)	
9922-700-0005	Checkered cap	
9922-700-0006	Black cap with axes	
9922-700-0007	B751 cap	
9922-700-0008	B1001 cap	
9922-120-0020	Beanie (black)	

Logosol mugs

Take a well-deserved coffee break with a Logosol mug.



9922-700-0009	Coffee mug, stoneware (white)	
9922-700-0010	Coffee mug, porcelain (orange)	
9922-700-0011	Thermos mug	

Logosol profile products!

Our Logosol-labelled tools and accessories are useful both in the woodworking shop and out on the sawmill site. The folding rule is a favourite, as well as the useful folding square!



NO-200	NOBEX Folding Square Quattro Carbon	
9922-130-0000	Folding rule	
650707	Carpenter's pencil	

LOGOSOL orders and delivery

Place your order the way that suits you!



E-store

Place your order on the web. You find all machines and accessories in our e-store on logosol.com.



Phone

Call +46 611-18285. We receive your order by phone every weekday 8.00 am–4.00 pm (CET). Our sales-staff is not commission-based, they will make sure that you get exactly what suits you!



Email

Contact us by email, info@logosol.com.



Mail and fax

Send your order form to Fiskaregatan 2, SE-871 33, Härnösand, SWEDEN, or fax on +46 611 18289.



Visit the Logosol store in Härnösand

You find the shop at Logosol's headquarters in Härnösand, Sweden. If you want to see the machines in operation, just give us a call before you are coming, so we can receive you the best possible way. Besides selling our machines and accessories, we are dealers for Stihl's and Viking's entire range of products.



Find us!

Visit our premises on Fiskaregatan 2 in Härnösand, Sweden. LOGOSOL keeps open all weekdays between 8.00 am–4.00 pm. We are happy to offer you a cup of coffee if you happen to be coming this way!



Payment methods

Credit card

Make your payment by credit card with order.

Bank transfer

You can make a bank transfer payment direct into our account.

Deposit

Deposit of 10% taken for larger equipment with balance due on item leaving for delivery.



The Logosol concept

Peace of mind

Logosol's peace-of-mind package provides you with a 2 year warranty and the right to return products within 2 months from date of delivery if they fail to live up to your expectations.

Quick delivery

Very speedy delivery of accessories and spare parts.

Unlimited support

Unlimited telephone support when it comes to product know-how and product use.

Long experience

Access to over 25 years' experience as market leader in the field of small-scale timber processing.

Our low freight costs

Our freight prices are based on weight, and we usually deliver immediately ex-stock. During the peak season delivery times may be slightly longer. We do not apply any service charges.

Damage in transit

If on receipt you discover that something is missing or has been damaged in transit, you must inform the driver of this straight away. Please contact us if the carrier does not accept responsibility for the damage.

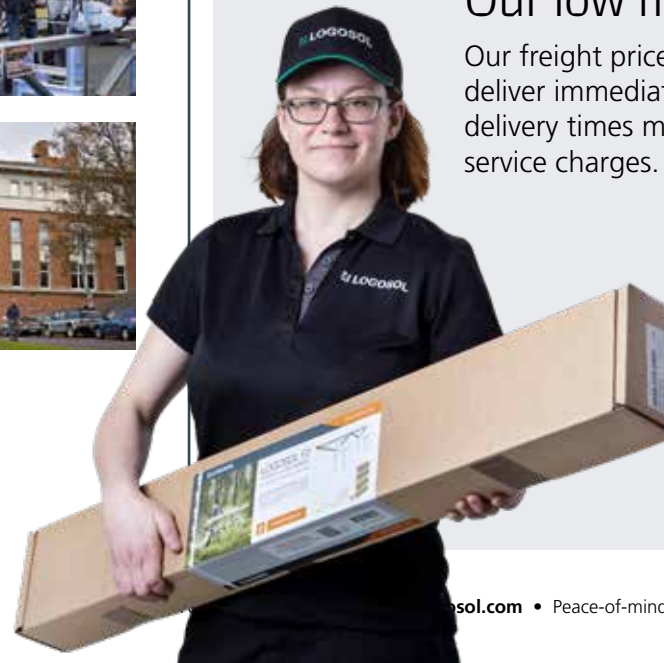

We are experts at small-scale wood processing. You are welcome to call and tell us about your project plans!

LOGOSOL service and warranties



Peter chooses machines from Logosol

For Östersund Joinery & Service in Sweden, Logosol is the obvious choice. "We work with people with varying backgrounds. To us, it is important that the machines are easy to use and that there are clear instructions. With Logosol it is easy to get good results, and their website has videos and handbooks that you can download," foreman Peter Madsen says. A favourite is the handbook From Log to Boards, which he frequently uses as a reference book. His working team has, among other things, built ski racks and benches for a ski station.



Always quick deliveries

Träkultur (Wood Culture) in Sidensjö, Sweden, builds and renovates log houses. Three conjoined Farmer's chain sawmills equipped with an electric saw unit are the core of the business. The machinery assembly also includes a four-sided planer/moulder PH260. "We also produce panelling and beaded mouldings, sometimes in short series. For this I order custom-made moulding knives. I always get quick deliveries and good service from Logosol," says Marcus Lindgren.

Do you have a business concept within wood processing – or do you want your business to develop?

Machines from Logosol are used in many successful companies and we have helped hundreds of customers to start their own businesses within small-scale wood processing. We can offer you training days, contact with reference customers, phone support and inspiring marketing materials without cost.



Examples of business concepts

Sawmills

Advanced tree felling and special sawing.

Joinery

Create unique wood products of local raw material.

Planer/moulders

Offer unique moulding profiles of your own or the customers design.

Industry

Get higher capacity with your own production line.

2-year warranty

Applies to all of our machines. The warranty covers manufacturing defects and problems that have occurred during normal use of the products. Exceptions to the warranty are consumable items such as belts, guide bars and saw chains.



2-month money back guarantee

Applies to all of our machines. This means that you can try the machine before deciding. Saw, plane or mould a good deal of timber, we are not afraid of taking back a machine with a little sawdust on it. You pay for the used cutting tools and the costs of return shipping, but that's all.



Service and support

As a Logosol customer you get unlimited phone support. Our knowledgeable staff answers your questions by phone every weekday from 8.00 am to 4.00 pm. You can also receive support via email or the chat service on our website.





PH260:

Insert 50 cents in one end, and get € 3.50 at the other, that's how this planer works.

Tobias Eklind



F2:

This is a sawmill well suited for large logs. There are still many cabins to build.

Freddy Lindfors



B751:

Properly handled, I can get a thousand pounds out of a single log.

John Lewis

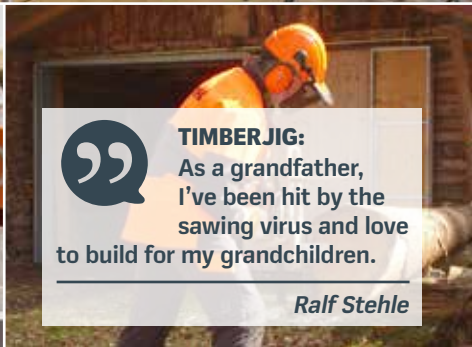

TIMBER JIG:

As a grandfather, I've been hit by the sawing virus and love to build for my grandchildren.

Ralf Stehle



BIG MILL:

I'm impressed by the wood boards you can saw with this. I have many ideas on how they can be used.

Johan Svensson



PH365:

We have to be flexible and able to deliver the products our customers want; then we must have machines we can rely on.

Mattias Sedenberg

